



CONTACT

 (+972) 53-938-9696

 www.sda-tech.co.il

 office@sda-tech.com

 המסגר 9, מגדל העמק, ישראל

פרופיל חברת S.D.A

חברת SDA נמנית עם החברות המובילות בתחום המשאבות וואקום בישראל. מייסד החברה, דוד כהן, מהנדס ובעל ניסיון נרחב מעל ל-30 שנות ניסיון במערכות וואקום, תכנון, והקמה ואחזקה של מערכות וואקום לכל התעשיות בארץ.

כמו כן, חברתנו מוכרת ומתחזקת משאבות וואקום של כל החברות בעולם. חברתנו מייצרים מערכות, משפצים ומשווקים מגוון סוגי משאבות לענפי התעשייה, ולתעשיית הסמיקונדקטור. בתחומים אלו צברנו ניסיון מקצועי של מעל ל-25 שנים, לצד לקוחות מרוצים כגון:
Tower Semiconductor, KLA, Applied Materials, Teva, SCD, IAI, AMAT, אלביט מערכות, בתי חולים, חברת החשמל, תרכובות ברום,

כמו כן, חברתנו מתחזקת משאבות מכל הסוגים לחברות הגדולות בתעשייה. למעלה מ-1300 חברות בשוטף כגון: **TOWER, Applied Materials, תומר**, ועוד.

בנוסף, חברת SDA מייצגת בבלעדיות את חברות:
Thermofisher, Trillium, MIL'S, Shellback, PTB, RF Global, Turbo Vac, Quartztec, Solvay, Sigma

היתרונות של חברת S.D.A Semiconductor Ltd:

מתן מענה מידי לצרכים שונים והתאמת ציוד הולם לכל דרישה. כולל תכנון הנדסי של מערכות וואקום Turn-key.
תיקון ואחזקה שוטפת לכל סוגי המשאבות וואקום של כל יצרני המשאבות.
אספקת כל סוגי המשאבות ושילובן האופטימלי במערכות קיימות או חדשות. ייצוג חברות בינלאומיות מובילות בתחום הספקת משאבות וציוד נלווה. מתן ייעוץ טכני-והנדסי ברמה גבוהה.



CONTACT

 (+972)53-938-9696

 www.sda-tech.co.il

 office@sda-tech.com

 המסגר 9, מגדל העמק, ישראל

מוצרי הדגל שלנו:

- | | |
|---|--------------------------------------|
| <u>פילטרים וסינון בוואקום</u> ✓ | <u>משאבות וואקום רטובות</u> ✓ |
| <u>חלקים וקיטים לכל סוגי המשאבות וואקום</u> ✓ | <u>משאבות IH, iPX, EPX, Stokes</u> ✓ |
| <u>QUARTZ לתעשיית הסמיקונדקטור</u> ✓ | <u>משאבות וואקום טבעת מים</u> ✓ |
| <u>מפוחים</u> ✓ | <u>משאבות וואקום למעבדות</u> ✓ |
| <u>RE לתעשיית הסמיקונדקטור</u> ✓ | <u>מערכות קירור חיצוניות</u> ✓ |
| <u>תיקוני רובוטים לתעשיית הסמיקונדקטור</u> ✓ | <u>משאבות טורבומולקולריות</u> ✓ |
| <u>כל סוגי מחברי הוואקום</u> ✓ | <u>משאבות Cryo</u> ✓ |
| <u>מערכות בקרה ותכנון הנדסי למפעלים</u> ✓ | <u>משאבות SCROLL</u> ✓ |
| <u>חלקי וואקום לשיפוצים וחלקי חילוף</u> ✓ | <u>מערכות לטיפול בגזי פליטה</u> ✓ |

תוכן עניינים/Contents

KF/NW Flanges & Fittings	3~20
ISO Flanges & Fittings	21~33
CF Flanges & Fittings	34~49
Bellows & Flexible Hoses	50~67
Pipe Fittings	68~103
Centering Rings.....	104~125
126~146.....	Vacuum adaptors
147~174.....	Vacuum Valves
175~176.....	Vacuum Chambers
177~183	OILS



KF/NW series



General information

KF/NW series are also called QF (quick flanges) in some areas.

The typical KF or NW assembly consists of two identical flanges, a center-ring, and an aluminum clamp or stainless-steel clamp with a wingnut fastener frequently connect and disconnect without tools.

The vacuum seal is affected by uniform application of pressure by the clamp on 15-degree surface of the flange.

The flange surface roughness is defined as Ra1.2.

The mating flange surfaces compress an O-ring holding in place by center ring to generate a seal.

סדרת **KF/NW**, הנקראת גם **QF (Quick Flange)** בחלק מהאזורים, משמשת לחיבורים בוואקום. ההרכבה כוללת שני אוגנים זהים, טבעת מרכזית עם O-Ring ומהדק מאלומיניום או נירוסטה עם בורג פרפר, שמאפשר חיבור וניתוק ללא צורך בכלים.

האיטום מושג בלחץ אחיד של המהדק על משטח בזווית של 15° . דרגת חספוס המשטח היא **Ra 1.2**, וה O-Ring נלחץ בין האוגנים ליצירת איטום בוואקום.



CONTACT

 (+972)53-938-9696

 www.sda-tech.co.il

 office@sda-tech.com

 המסגר 9, מגדל העמק, ישראל

Specifications

Blanks: SS304(Aluminum or SS316L available upon request)

Flanges: SS304(SS316L available upon request)

Fittings: SS304(SS316L available upon request). Please refer to separate fittings part.

Clamps: Aluminum, SS304

O-ring material: Viton, NBR.

Please refer to separate center rings O-rings part.

Center ring material: aluminum, SS304, SS316, Teflon.

Please refer to separate center rings O-rings part.

Vacuum rate: 10^{-8} torr Temperature range: 150°C(Viton), 80°C(NBR),

Size range: NW10, NW16, NW25, NW40, NW50 Larger or special size available upon request.

חלקי ריק: SS304 (אלומיניום או SS316L זמינים לפי בקשה)

אוגנים: SS304 (SS316L זמינים לפי בקשה)

אביזרים: SS304 (SS316L זמינים לפי בקשה). אנא עיינו בחלק נפרד של האביזרים.

מהדקים: אלומיניום, SS304

חומר טבעת O: ויטון, NBR.

אנא עיינו בחלק נפרד של טבעות O לטבעות מרכזיות.

חומר טבעת מרכזית: אלומיניום, SS316, SS304, טפלון.

אנא עיינו בחלק נפרד של טבעות O לטבעות מרכזיות.

טווח טמפרטורות: 150°C (ויטון), 80°C (NBR), קצב ואקום: 8-10 טור

טווח גדלים: NW10, NW16, NW25, NW40, NW50. גודל גדול יותר או מיוחד זמין לפי בקשה.

עמוד 4 מתוך 183



CONTACT

 (+972)53-938-9696

 www.sda-tech.co.il

 office@sda-tech.com

 המסגר 9, מגדל העמק, ישראל

KF / NW wing-nut clamp type 1 (double-pin)

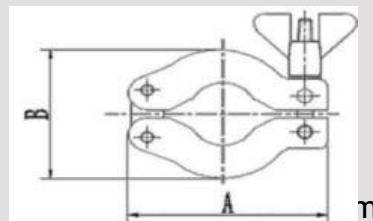

Model No.	Quality	A	B	C	Part No.
NW10/16	Aluminum	63	41	16	SDA-00051
NW25		72	53	16	SDA-00052
NW40		90	68	17	SDA-00053
NW50		113	90	20	SDA-00054
NW10/16	304	63	41	16	SDA-00055
NW25		72	53	16	SDA-00056
NW40		90	68	17	SDA-00057
NW50		113	90	20	SDA-00058

KF/NW wing-nut clamp type 2 (single-pin)

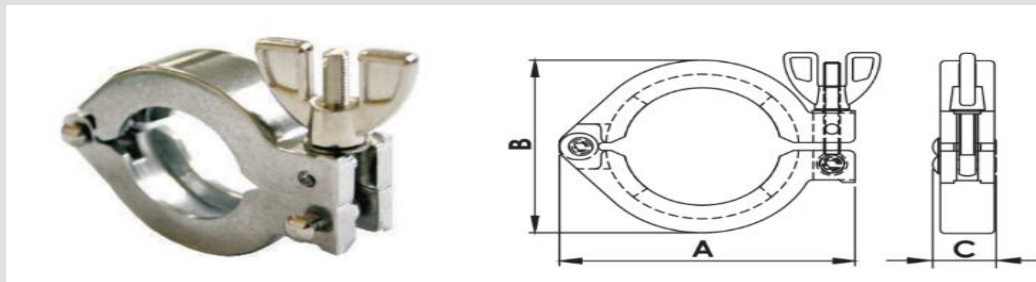

Material: SS304, Aluminum

Model No.	Quality	A	B	C	Part No.
NW10/16	Aluminum	62	42.5	16.5	SDA-00059
NW25		72	54	17	SDA-00060
NW40		90	72	17.2	SDA-00061
NW50		114	93	20.5	SDA-00062
NW10/16	304	63	41	16	SDA-00063
NW25		72	53	16	SDA-00064
NW40		90	72	17	SDA-00065
NW50		114	93	20	SDA-00066



CONTACT

 (+972)53-938-9696

 www.sda-tech.co.il

 office@sda-tech.com

 המסגר 9, מגדל העמק, ישראל

wall clamps with bolts.

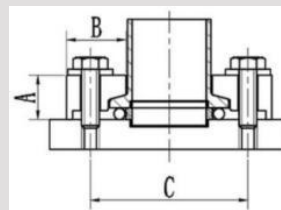

Material: Aluminum with stainless steel screw

Model No.	A	B	C	Application No.	Part No.
NW10	15	20	43	3	SDA-00067
NW16	15	20	43	3	SDA-00068
NW25	15	20	53	4	SDA-00069
NW40	15	20	68	4	SDA-00070
NW50	15	20	88	6	SDA-00071

KF/NW spring clamp

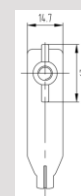
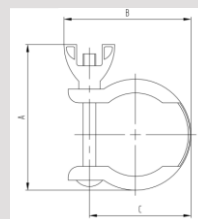

Material: SS304 with stainless steel screw

Model No.	A	B	C	Part No.
NW10	55	54	40	SDA-00072
NW16	55	54	40	SDA-00073
NW25	63	62	48	SDA-00074
NW40	77	76	62	SDA-00075

KF/NW CNC machined clamp



Material: SS304 with stainless steel screw, CNC machined

Model No.	A	B	C	Part No.
NW16	55	54	40	SDA-00076
NW25	63	62	48	SDA-00077
NW40	77	76	62	SDA-00078
NW50	77	76	62	SDA-00077

KF/NW bulkhead clamp

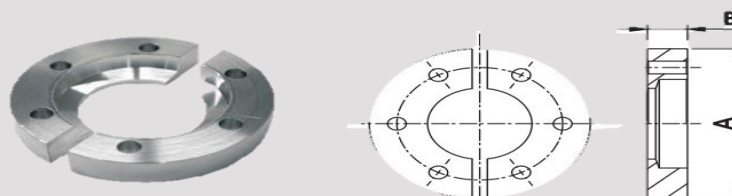

Material: Aluminum, 304

Metric thread and UNF could be applied.

Model No.	A	B	D of hole	No. of Holes	Part No.
NW10	50.8	9.2	4.3	6	SDA-00078
NW16	50.8	9.2	5.3	6	SDA-00079
NW25	60.3	9.9	5.3	6	SDA-00080
NW40	74.6	9.3	5.3	6	SDA-00081
NW50	95.2	10.3	5.3	8	SDA-00082



CONTACT

 (+972)53-938-9696

 www.sda-tech.co.il

 office@sda-tech.com

 המסגר 9, מגדל העמק, ישראל

KF/NW small chain clamp

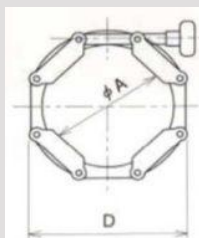

Material: Al+304+copper

Model No.	A	D	T	Part No.
NW10	22	60	20	SDA-00083
NW16	22	60	20	SDA-00084
NW25	32	70	20	SDA-00085
NW40	47	85	20	SDA-00086
NW50	67	105	20	SDA-00087
NW63	79	120	20	SDA-00088

KF/NW large chain clamp

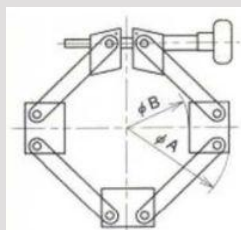

Material: Al+304

Model No.	A	B	T	Part No.
ISO80	165	100	37	SDA-00089
ISO100	185	122	37	SDA-00090
ISO125	210	150	37	SDA-00091
ISO160	235	174	37	SDA-00092
ISO200	300	239	37	SDA-00093
ISO250	350	288	37	SDA-00094

עמוד 9 מתוך 183

KF/NW blank flange

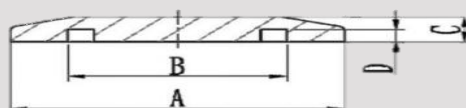

Material: 304,304L,316L, Aluminum based on buyers' request.

Model No.	A	B	C	D	Part No.
NW10	30	12.2	5	2.5	SDA-00095
NW16	30	17.2	5	2.5	SDA-00096
NW25	40	26.2	5	2.5	SDA-00097
NW40	55	41.2	5	2.5	SDA-00098
NW50	75	52.2	5	2.5	SDA-00099
ISO63	87	70	5	2.5	SDA-00100
ISO80	114	83	12	4.5	SDA-00101
ISO100	134	102	12	4.5	SDA-00102
ISO160	190	153	12	4.5	SDA-00103
ISO200	252	213	12	4.5	SDA-00104

KF/NW blank flange type 2

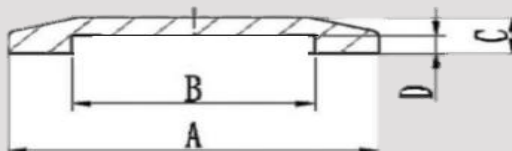

Material: 304,304L,316L, Aluminum based on buyers' request.

Model No.	A	B	C	D	Part No.
NW10	30	12.2	5	2.5	SDA-00105
NW16	30	17.2	5	2.5	SDA-00106
NW25	40	26.2	5	2.5	SDA-00107
NW40	55	41.2	5	2.5	SDA-00108
NW50	75	52.2	5	2.5	SDA-00109
ISO63	87	70	5	2.5	SDA-00110
ISO80	114	83	12	4.5	SDA-00111
ISO100	134	102	12	4.5	SDA-00112
ISO160	190	153	12	4.5	SDA-00113
ISO200	252	213	12	4.5	SDA-00114

KF/NW bored flange

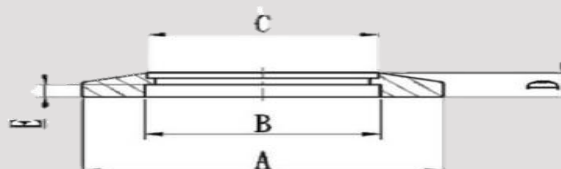
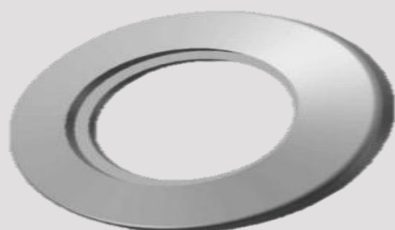

Material: 304,304L,316L, Aluminum based on buyers' request.

Model No.	Type	A	B	C	D	E	Part No.
NW10*038	without step	30	12.2	9.65	5	2.5	SDA-00115
NW16*025	without step	30	17.2	6.5	5	2.5	SDA-00116
NW16*038	without step	30	17.2	9.65	5	2.5	SDA-00117
NW16*050	with step 10.16mm	30	17.2	12.95	5	2.5	SDA-00118
NW16*075	with step 16.51mm	30	17.2	19.3	5	2.5	SDA-00119
NW25*025	without step	40	26.2	6.5	5	2.5	SDA-00120
NW25*038	without step	40	26.2	9.65	5	2.5	SDA-00121
NW25*050	with step 10.16mm	40	26.2	12.95	5	2.5	SDA-00122
NW25*075	with step 16.51mm	40	26.2	19.3	5	2.5	SDA-00123
NW25*100	with step 22.88mm	40	26.2	25.65	5	2.5	SDA-00124
NW40*025	without step	55	41.2	6.5	5	2.5	SDA-00125
NW40*038	without step	55	41.2	9.65	5	2.5	SDA-00126
NW40*050	with step 10.16mm	55	41.2	12.95	5	2.5	SDA-00127
NW40*075	with step 16.51mm	55	41.2	19.3	5	2.5	SDA-00128
NW40*100	with step 22.88mm	55	41.2	25.65	5	2.5	SDA-00129



CONTACT

 (+972)53-938-9696

 www.sda-tech.co.il

 office@sda-tech.com

 המסגר 9, מגדל העמק, ישראל

NW40*150	with step 35.58mm	55	41.2	38.35	5	2.5	SDA-00130
NW50*025	without step	75	52.2	6.5	5	2.5	SDA-00131
NW50*038	without step	75	52.2	9.65	5	2.5	SDA-00132
NW50*050	with step 10.16mm	75	52.2	12.95	5	2.5	SDA-00133
NW50*075	with step 16.51mm	75	52.2	19.3	5	2.5	SDA-00134
NW50*100	with step 22.88mm	75	52.2	25.65	5	2.5	SDA-00135
NW50*150	with step 35.58mm	75	52.2	38.35	5	2.5	SDA-00136
NW50*200	with step 48.26	75	52.2	51.05	5	2.5	SDA-00137
ISO63*250	with step	87	70	63.7	5	2.5	SDA-00138
ISO80*300	with step	114	83	76.4	12	4.5	SDA-00139
ISO100*400	with step	134	102	101.8	12	4.5	SDA-00140
ISO125*500	with step	161	127	127.2	12	4.5	SDA-00141
ISO160*600	with step	190	153	152.9	12	4.5	SDA-00142
ISO200*800	with step	252	213	204.3	12	4.5	SDA-00143

KF/NW socket weld flange, short

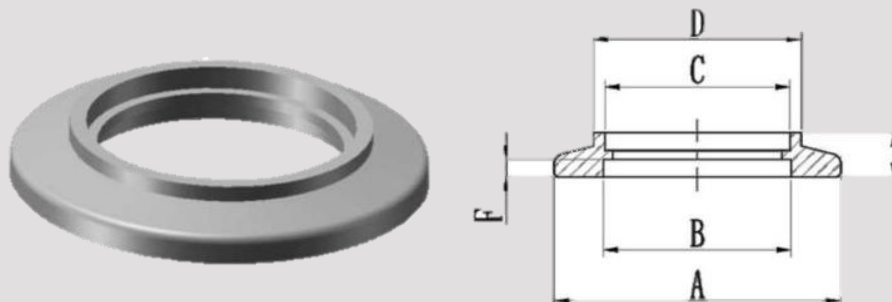

Material: 304,304L,316L

Model No.	A	B	C	D	E	F	Part No.
NW10	30	12.2	12.9	13	6.35	2.5	SDA-00144
NW16	30	17.2	19.3	19.3	6.35	2.5	SDA-00145
NW25	40	26.2	25.7	28	6.35	2.5	SDA-00146
NW40	55	41.2	38.4	45	6.35	2.5	SDA-00147
NW50	75	52.2	51	57	6.35	2.5	SDA-00148
ISO63	87	70	63.7	67.5	6.35	2.5	SDA-00149
ISO80	114	83	76.4	89	12.7	4.5	SDA-00150
ISO100	134	102	101.8	108	12.7	4.5	SDA-00151
ISO125	161	127	127.2	134	12.7	4.5	SDA-00152
ISO160	190	153	152.9	165	12.7	4.5	SDA-00153
ISO200	252	213	204.3	219	12.7	4.5	SDA-00154

KF/NW socket weld flange long

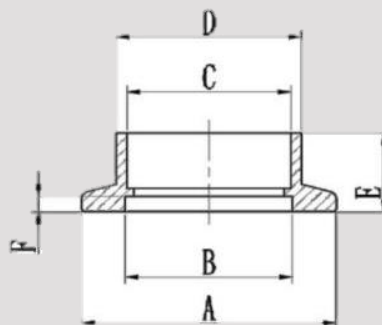
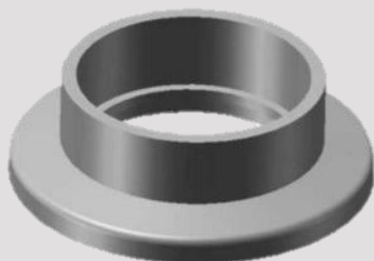

Material: 304,304L,316L

Model No.	A	B	C	D	E	F	Part No.
NW10	30	12.2	12.9	13	12.7	2.5	SDA-00155
NW16	30	17.2	19.3	19.3	12.7	2.5	SDA-00156
NW25	40	26.2	25.7	28	12.7	2.5	SDA-00157
NW40	55	41.2	38.4	45	12.7	2.5	SDA-00158
NW50	75	52.2	51	57	12.7	2.5	SDA-00159
ISO63	87	70	63.7	67.5	12.7	2.5	SDA-00160
ISO80	114	83	76.4	89	20	4.5	SDA-00161
ISO100	134	102	101.8	108	20	4.5	SDA-00162
ISO125	161	127	127.2	134	20	4.5	SDA-00163
ISO160	190	153	152.9	165	20	4.5	SDA-00164
ISO200	252	213	204.3	219	20	4.5	SDA-00165

KF/NW butt weld stub flanges, short (20)

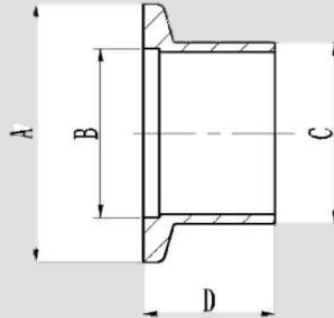
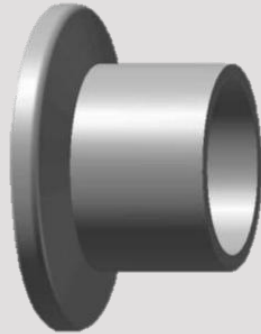

Material: 304,304L,316L

Model No.	Standard	A	B	C	D	Part No.
NW20-10	US	30	12.2	12.7	20	SDA-00166
NW20-16	US	30	17.2	19.05	20	SDA-00167
NW20-25	US	40	26.2	25.4	20	SDA-00168
NW20-40	US	55	41.2	38.1	20	SDA-00169
NW20-50	US	75	52.2	50.8	20	SDA-00170
NW20-10	EU	30	12.2	14	20	SDA-00171
NW20-16	EU	30	17.2	20	20	SDA-00172
NW20-25	EU	40	26.2	28	20	SDA-00173
NW20-40	EU	55	41.2	45	20	SDA-00174
NW20-50	EU	75	52.2	57	20	SDA-00175
NW20-25	JIS	40	26.2	27.2	20	SDA-00176
NW20-40	JIS	55	41.2	42.7	20	SDA-00177
NW20-50	JIS	75	52.2	60.5	20	SDA-00178

KF/NW butt weld stub flanges (30)

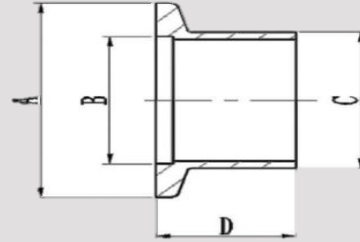
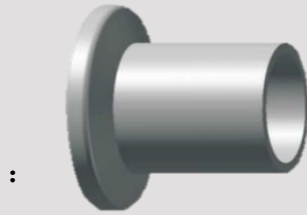

Material

304,304L,316L

Model No.	Standard	A	B	C	D	Part No.
NW30-10	US	30	12.2	12.7	30	SDA-00179
NW30-16	US	30	17.2	19.05	30	SDA-00180
NW30-25	US	40	26.2	25.4	30	SDA-00181
NW30-40	US	55	41.2	38.1	30	SDA-00182
NW30-50	US	75	52.2	50.8	30	SDA-00183
NW30-10	EU	30	12.2	14	30	SDA-00184
NW30-16	EU	30	17.2	20	30	SDA-00185
NW30-25	EU	40	26.2	28	30	SDA-00186
NW30-40	EU	55	41.2	45	30	SDA-00187
NW30-50	EU	75	52.2	57	30	SDA-00188
NW30-25	JIS	40	26.2	27.2	30	SDA-00189
NW30-40	JIS	55	41.2	42.7	30	SDA-00190
NW30-50	JIS	75	52.2	60.5	30	SDA-00191

KF/NW butt weld stub flanges (40)

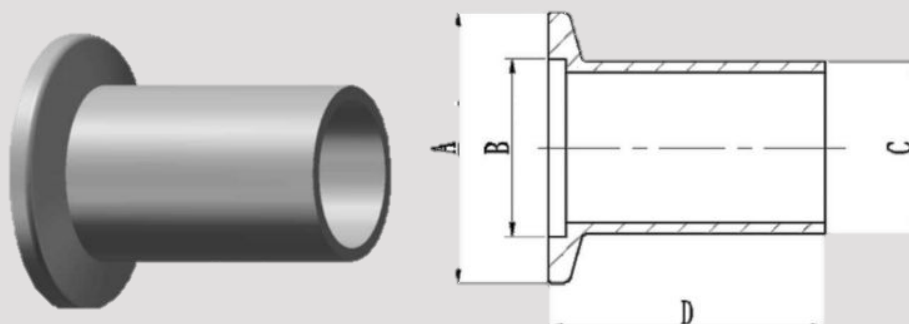

Material: 304,304L,316L

Model No.	Standard	A	B	C	D	Part No.
NW40-10	US	30	12.2	12.7	30	SDA-00192
NW40-16	US	30	17.2	19.05	30	SDA-00193
NW40-25	US	40	26.2	25.4	30	SDA-00194
NW40-40	US	55	41.2	38.1	30	SDA-00195
NW40-50	US	75	52.2	50.8	30	SDA-00196
NW40-10	EU	30	12.2	14	30	SDA-00197
NW40-16	EU	30	17.2	20	30	SDA-00198
NW40-25	EU	40	26.2	28	30	SDA-00199
NW40-40	EU	55	41.2	45	30	SDA-00200
NW40-50	EU	75	52.2	57	30	SDA-00201
NW40-25	JIS	40	26.2	27.2	30	SDA-00202
NW40-40	JIS	55	41.2	42.7	30	SDA-00203
NW40-50	JIS	75	52.2	60.5	30	SDA-00204

KF/NW butt weld stub flanges (50)

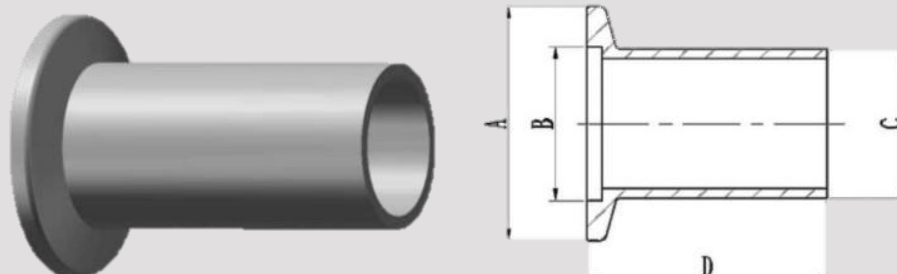

Material: 304,304L,316L

Model No.	Standard	A	B	C	D	Part no.
NW40-10	US	30	12.2	12.7	30	SDA-00205
NW50-16	US	30	17.2	19.05	30	SDA-00206
NW50-25	US	40	26.2	25.4	30	SDA-00207
NW50-40	US	55	41.2	38.1	30	SDA-00208
NW50-50	US	75	52.2	50.8	30	SDA-00209
NW50-10	EU	30	12.2	14	30	SDA-00210
NW50-16	EU	30	17.2	20	30	SDA-00211
NW50-25	EU	40	26.2	28	30	SDA-00212
NW50-40	EU	55	41.2	45	30	SDA-00213
NW50-50	EU	75	52.2	57	30	SDA-00214
NW50-25	JIS	40	26.2	27.2	30	SDA-00215
NW50-40	JIS	55	41.2	42.7	30	SDA-00216
NW50-50	JIS	75	52.2	60.5	30	SDA-00217

KF/NW butt weld stub flanges (70)

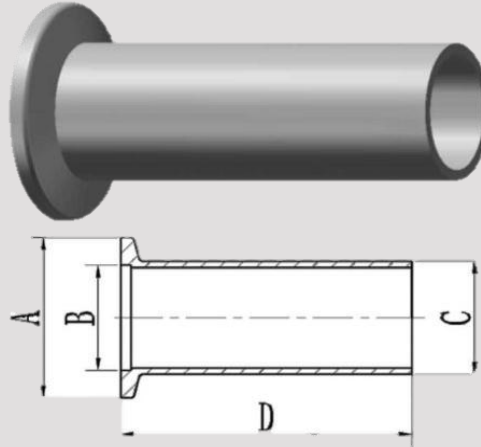

Material: 304,304L,316L

Model No.	Standard	A	B	C	D	Part No.
NW70-10	US	30	12.2	12.7	30	SDA-00218
NW70-16	US	30	17.2	19.05	30	SDA-00219
NW70-25	US	40	26.2	25.4	30	SDA-00220
NW70-40	US	55	41.2	38.1	30	SDA-00221
NW70-50	US	75	52.2	50.8	30	SDA-00222
NW70-10	EU	30	12.2	14	30	SDA-00223
NW70-16	EU	30	17.2	20	30	SDA-00224
NW70-25	EU	40	26.2	28	30	SDA-00225
NW70-40	EU	55	41.2	45	30	SDA-00226
NW70-50	EU	75	52.2	57	30	SDA-00227
NW70-25	JIS	40	26.2	27.2	30	SDA-00228
NW70-40	JIS	55	41.2	42.7	30	SDA-00229
NW70-50	JIS	75	52.2	60.5	30	SDA-00230

מידע כללי

מבנה סדרת האוגנים ISO כולל שני אוגנים חלקים ללא מין המחוברים יחד באמצעות טבעת מרכז מתכת משולבת וטבעת O ויטון ביניהם. רכיבי ISO ניתנים לשימוש חוזר וניתנים להחלפה עם רכיבים אחרים במידות ISO באותו גודל.

מפרט טכני

אוגנים וחלקים: SS304 (SS316L)
זמין לפי בקשה

טבעות קיבוע: SS304 (SS316L)
זמין לפי בקשה

חומר טבעת מרכזית: אלומיניום,
SS304, SS316

חומר טבעת O: ויטון, NBR

טבעות היצויות: אלומיניום,
SS304

מלחציים: אלומיניום, SS304,
פלדת פחמן מצופה אבץ

אביזרים: SS304 (SS316L) זמין
לפי בקשה

טווח טמפרטורות: 150°C (ויטון),
80°C (NBR)

קצב ואקום: 8-10 טור

טווחים

ISO63, ISO80, ISO100,
ISO160, ISO200, ISO250,
ISO320, ISO400, ISO500
גודל גדול יותר או מיוחד זמין לפי
בקשה.

ISO series

General information

ISO series are also called LF (large flanges).

The components of ISO universal flange system are defined by the International Standards



Organization (ISO).

The construction of ISO flange series includes two smooth-faced sexless flanges clamped together with a combination metal centering ring and Viton O-ring between them.

ISO components are reusable and changeable with other ISO dimension components of the same size.

Specifications

Blanks & Flanges: SS304(SS316L available upon request)

Retainer rings: SS304(SS316L available upon request)

Center ring material: aluminum, SS304, SS316

O-ring material: Viton, NBR

Outer rings: Aluminum, SS304

Clamps: Aluminum, SS304, carbon steel Zn plated

Fittings: SS304(SS316L available upon request)

Temperature range: 150°C(Viton), 80°C(NBR)

Vacuum rate: 10⁻⁸ torr

Size

range

ISO63, ISO80, ISO100, ISO160, ISO200, ISO250, ISO320, ISO400,
ISO500 Larger or special size available upon request.

עמוד 21 מתוך 183

ISO-K blank flange

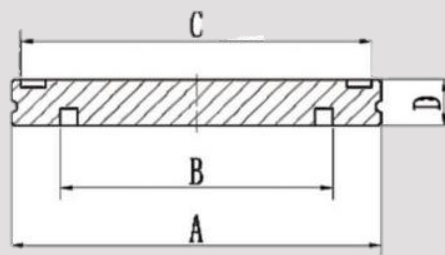

Material: 304,304L,316L

Model No.	A	B	C	D	Part No.
ISO63	95	70	90	12	SDA-00231
ISO80	110	83	105	12	SDA-00232
ISO100	130	102	125	12	SDA-00233
ISO125	155	127	150	12	SDA-00234
ISO160	180	153	175	12	SDA-00235
ISO200	240	213	235	12	SDA-00236
ISO250	290	261	285	12	SDA-00237
ISO320	370	318	365	17	SDA-00238
ISO400	450	400	445	17	SDA-00239
ISO500	550	501	545	17	SDA-00240
ISO630	690	651	685	22	SDA-00241

ISO-K Bored flange

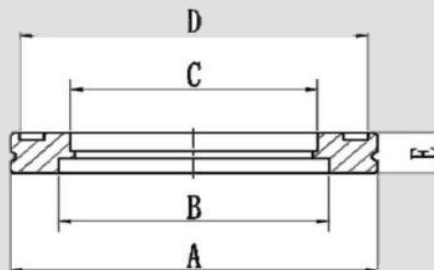
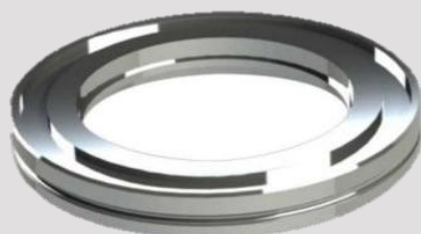

Material: 304,304L,316L

Remark: Other sizes could be customized based on special tube sizes.

Model No.	A	B	C	D	E	Part No.
ISO63-63	95	70	63.7	90	12	SDA-01563
ISO80-76	110	83	76.4	105	12	SDA-01564
ISO100-102	130	102	101.8	125	12	SDA-01565
ISO125-127	155	127	127.5	150	12	SDA-01566
ISO160-152	180	153	152.9	175	12	SDA-01567
ISO200-204	240	213	203.7	235	12	SDA-01568
ISO250-254	290	261	254.5	285	12	SDA-01569
ISO320-305	370	318	305.3	365	17	SDA-01570
ISO400-407	450	400	406.9	445	17	SDA-01571
ISO500-508	550	501	508.8	545	17	SDA-01572
ISO630-610	69	651	610.5	685	22	SDA-01573

ISO-F blank flange

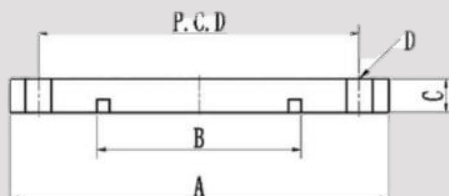
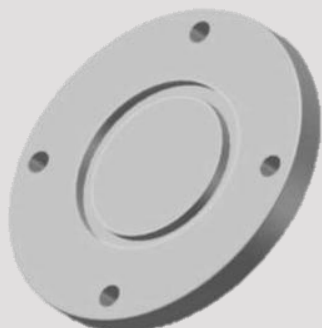

Material: 304,304L,316L

Model No.	A	B	C	D*N O	P.C. D	Part No.
ISO63	130	70	12	9*4	110	SDA-00248
ISO80	145	83	12	9*8	125	SDA-00249
ISO100	165	102	12	9*8	145	SDA-00250
ISO125	200	127	12	11*8	175	SDA-00251
ISO160	225	153	16	11*8	200	SDA-00252
ISO200	285	213	16	11*8	260	SDA-00253
ISO250	335	261	16	11*8	310	SDA-00254
ISO320	425	318	20	14*8	395	SDA-00255
ISO400	510	400	20	14*8	480	SDA-00256
ISO500	610	501	20	14*8	580	SDA-00257
ISO630	750	651	24	14*8	720	SDA-00258

ISO-F Bored flange

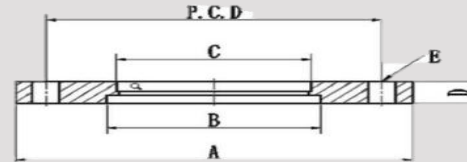
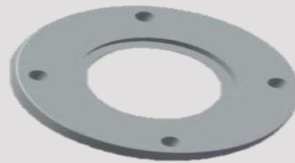

Material: 304,304L,316L

Remark: Other sizes could be customized based on special tube sizes

Model No.	A	B	C	D	E*NO	P.C. D	Part No.
ISO63-63	130	70	63.7	12	9*4	110	SDA-00259
ISO80-76	145	83	76.4	12	9*8	125	SDA-00260
ISO100-102	165	102	101.8	12	9*8	145	SDA-00261
ISO125-127	200	127	127.5	12	11*8	175	SDA-00262
ISO160-152	225	153	152.9	16	11*8	200	SDA-00263
ISO200-204	285	213	203.7	16	11*8	260	SDA-00264
ISO250-254	335	261	254.5	16	11*8	310	SDA-00265
ISO320-305	425	318	305.3	20	14*8	395	SDA-00266
ISO400-407	510	400	406.9	20	14*8	480	SDA-00267
ISO500-508	610	501	508.8	20	14*8	580	SDA-00268
ISO630-610	750	651	610.5	24	14*8	720	SDA-00269

ISO-F Bored flange with screw holes

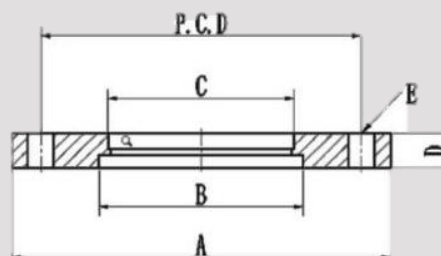
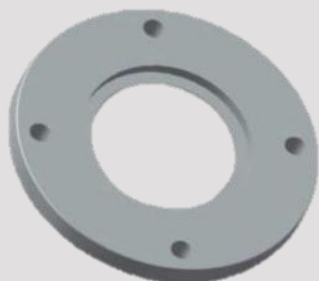

Material: 304,304L,316L

Remark: Other sizes could be customized based on special tube sizes.

Model No.	A	B	C	D	E*NO	P.C.D	Part No.
ISO63-63	130	70	63.7	12	M8*4	110	SDA-00270
ISO80-76	145	83	76.4	12	M8*8	125	SDA-00271
ISO100-102	165	102	101.8	12	M8*8	145	SDA-00272
ISO125-127	200	127	127.5	12	M10*8	175	SDA-00273
ISO160-152	225	153	152.9	16	M10*8	200	SDA-00274
ISO200-204	285	213	203.7	16	M10*8	260	SDA-00275
ISO250-254	335	261	254.5	16	M10*8	310	SDA-00276
ISO320-305	425	318	305.3	20	M12*8	395	SDA-00277
ISO400-407	510	400	406.9	20	M12*8	480	SDA-00278
ISO500-508	610	501	508.8	20	M12*8	580	SDA-00279
ISO630-610	750	651	610.5	24	M12*8	720	SDA-00280

ISO Rotatable flanges with SS rings

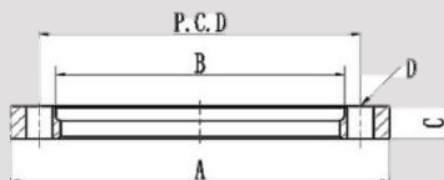
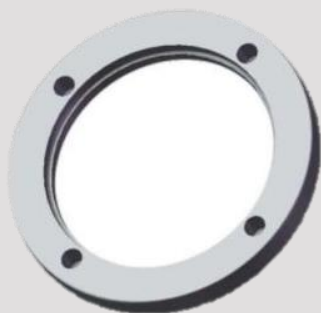

Material: 304,304L,316L

Model No.	A	B	C	D*No.	P.C.D	Part No.
ISO63	130	98.5	12	9*4	110	SDA-00281
ISO80	145	113.5	12	9*8	125	SDA-00282
ISO100	165	133.5	12	9*8	145	SDA-00283
ISO125	200	160.7	12	11*8	175	SDA-00284
ISO160	225	185.7	16	11*8	200	SDA-00285
ISO200	285	245.7	16	11*8	260	SDA-00286
ISO250	335	295.7	16	11*8	310	SDA-00287
ISO320	425	375.8	20	14*8	395	SDA-00288
ISO400	510	458.8	20	14*8	480	SDA-00289
ISO500	610	558.8	20	14*8	580	SDA-00290
ISO630	750	651	24	14*8	720	SDA-00291

ISO-K Half nipple

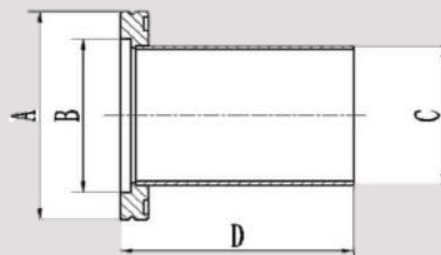

Material: 304,304L,316L

Model No.	A	B	C	D	Part No.
ISO63	95	70	63.5	100	SDA-00292
ISO80	110	83	76.2	100	SDA-00293
ISO100	130	102	101.6	100	SDA-00294
ISO125	155	127	127	100	SDA-00295
ISO160	180	153	152.4	100	SDA-00296
ISO200	240	213	203.2	100	SDA-00297
ISO250	290	261	254	100	SDA-00298
ISO320	370	318	304.8	100	SDA-00299
ISO400	4550	400	406.8	100	SDA-00300
ISO500	550	501	508	100	SDA-00301
ISO630	690	651	609.6	100	SDA-00302

ISO-F Half nipple

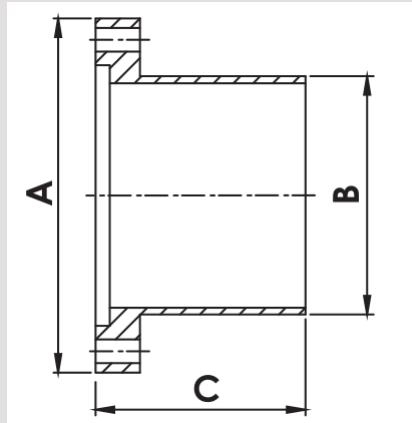

Material: 304,304L,316L

Model No.	A	B	C	T	P.C.D	Part No.
ISO63	130	63.7	100	12	110	SDA-00303
ISO80	145	76.4	100	12	125	SDA-00304
ISO100	165	101.8	100	12	145	SDA-00305
ISO125	200	127.5	100	12	175	SDA-00306
ISO160	225	152.9	100	16	200	SDA-00307
ISO200	285	203.7	100	16	260	SDA-00308
ISO250	335	254.5	100	16	310	SDA-00309
ISO320	425	305.3	100	20	395	SDA-00310
ISO400	510	406.9	100	20	480	SDA-00311
ISO500	610	508.8	100	20	580	SDA-00312
ISO630	750	610.5	100	24	720	SDA-00313



CONTACT

(+972)53-938-9696

www.sda-tech.co.il

office@sda-tech.com

המסגר 9, מגדל העמק, ישראל

ISO SS Single claw clamp

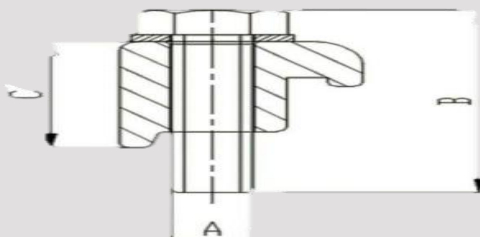

Material: 304 polishing

Model No.	A	B	C	Applied flange	Part No.
ISO-63100M	M8	35	23	ISO63	SDA-00314
				ISO80	
				ISO100	
ISO-160250M	M10	35	23	ISO160	SDA-00315
				ISO200	
				ISO250	
ISO-320500M	M12	50	30	ISO320	SDA-00316
				ISO400	
				ISO500	



CONTACT

 (+972)53-938-9696

 www.sda-tech.co.il

 office@sda-tech.com

 המסגר 9, מגדל העמק, ישראל

ISO Aluminum Single claw clamp

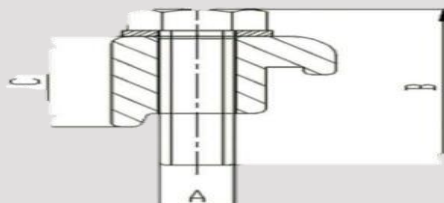

Material: Aluminum with stainless steel screw

Model No.	A	B	C	Applied flange	Part No.
ISO-63100M	M8	35	23.5	ISO63	SDA-00317
				ISO80	
				ISO100	
ISO-160250M	M10	35	23.5	ISO160	SDA-00318
				ISO200	
				ISO250	
ISO-320500M	M12	50	30	ISO320	SDA-00319
				ISO400	
				ISO500	

ISO Aluminum double claw clamp

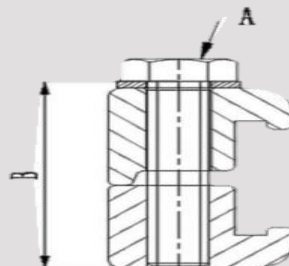

Material: Aluminum with stainless steel screw

Model No.	A	B	Applied quantity	Applied flange	Part No.
ISO-63100M	M8	45	4	ISO63	SDA-00320
			4	ISO80	
			4	ISO100	
ISO-160250M	M10	45	6	ISO160	SDA-00321
			6	ISO200	
			6	ISO250	
ISO-320500M	M12	60	8	ISO320	SDA-00322
			8	ISO400	
			12	ISO500	



CONTACT

 (+972)53-938-9696

 www.sda-tech.co.il

 office@sda-tech.com

 המסגר 9, מגדל העמק, ישראל

ISO SS double claw clamp

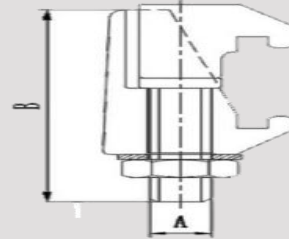

Material: SS304 with tumble finish

Model No.	A	B	Applied quantity	Applied flange	Part No.
ISO-63100M	M8	65	4	ISO63	SDA-00323
			4	ISO80	
			4	ISO100	
ISO-160250M	M10	70	4	ISO160	SDA-00324
			6	ISO200	
			6	ISO250	
ISO-320500M	M12	80	8	ISO320	SDA-00325
			8	ISO400	
			12	ISO500	



CONTACT 

 (+972)53-938-9696

 www.sda-tech.co.il

 office@sda-tech.com

 המסגר 9, מגדל העמק, ישראל

CF series





CONTACT

 (+972)53-938-9696

 office@sda-tech.com

 www.sda-tech.co.il

 המסגר 9, מגדל העמק, ישראל

General information

CF series are also called con-flat flanges.

The high sealing effect and the low leak rates performance of CF flange connections is a result of gasket material.

When assembling the CF flange connect, the knife edge is pressed into the flat copper gasket and force the seal material both axially as well as radially outwards to the flange.

The material is enclosed and cannot flow even at high bake-out temperature.

Due to this deformation of the seal such connections may sometimes stick together.

They can be easily separated with a special tool or screwdriver.

Offered in both rotatable and non-rotatable virions with through holes and tapped bolt holes.

Metric tapped holes and untapped holes flanges are identical UNC or UNF or other tapped holes can be ordered as products. specials.



CONTACT

 (+972)53-938-9696

 www.sda-tech.co.il

 office@sda-tech.com

 המסגר 9, מגדל העמק, ישראל

Specifications

Blanks Flanges: SS304 (other material available upon request)

Gaskets: OFHC copper Bolt: SS304

Fittings: SS304 (SS316L available upon request)

Temperature range: -200°C ~ -450°C (OFHC copper)

Vacuum rate: 10^{-11} torr

Torque Rating: CF35 and smaller 220kgf-cm.

CF63 and larger 360kgf-cm

Size range: CF16 ~ CF350 Larger or special size available upon request

סדרת CF נקראת גם אוגנים שטוחים. אפקט האיטום הגבוה ושיעורי הדליפה הנמוכים של חיבורי אוגן CF נובעים מחומר האטום.

אוגן אטימה: SS304 (חומר אחר זמין לפי בקשה)

אטמים: נחושת OFHC

בורג: SS304

פיזור: SS304 (SS316L זמין לפי בקשה)

טווח טמפרטורות: -200°C ~ 450°C (נחושת OFHC)

קצב ואקום: 10-11 טור

דירוג מומנט: CF35 ומטה 220 ק"ג-ס"מ.

CF63 ומעלה 360 ק"ג-ס"מ

טווח מידות: CF16 ~ CF350

מידות גדולות או מיוחדות זמינות לפי בקשה.

NW Blank flange with through holes

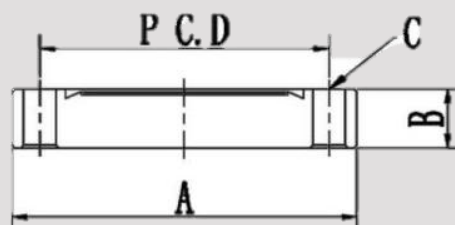
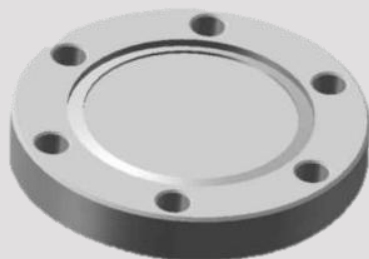

Material: 304 / 304L / 316 / 316L / 316LN

Model No.	A	B	C*No	P.C. D	Part No.
NW- 16(1.33")	34	7.3	4.4*6	27	SDA-00326
NW-25(2.12")	54	10.5	6.7*4	43	SDA-00327
NW-35(2.75")	70	13	6.7*6	58.7	SDA-00328
NW-50(3.38")	86	16	8.4*8	72.4	SDA-00329
NW-63(4.5")	114	17.5	8.4*8	92.2	SDA-00330
NW-80(4.62")	117	19	8.4*16	102.4	SDA-00331
NW-100(6")	152	20	8.4*16	130.3	SDA-00332
NW-160(8")	202	22	8.4*20	181	SDA-00333
NW-200(10")	253	24.5	8.4*24	231.8	SDA-00334
NW-250(12")	305	26	8.4*32	284	SDA-00326
NW-300(14")	355	28.45	10.49*30	325.37	SDA-00327
NW-350(16.5")	418	28.45	10.49*36	388.76	SDA-00328

CF Blank flange with threaded holes

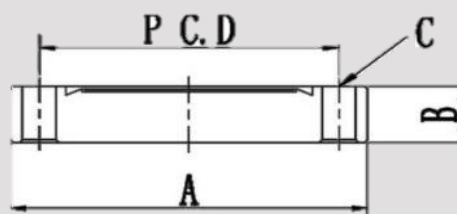
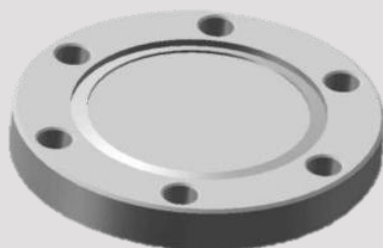

Material: 304 / 304L / 316 / 316L / 316LN

Model No.	A	B	C*No	P.C.D	Part No.
NW- 16(1.33")	34	7.3	M4*6	27	SDA-00329
NW-25(2.12")	54	10.5	M6*4	43	SDA-00330
NW-35(2.75")	70	13	M6*6	58.7	SDA-00331
NW-50(3.38")	86	16	M8*8	72.4	SDA-00332
NW-63(4.5")	114	17.5	M8*8	92.2	SDA-00333
NW-80(4.62")	117	19	M8*16	102.4	SDA-00334
NW-100(6")	152	20	M8*16	130.3	SDA-00335
NW-160(8")	202	22	M8*20	181	SDA-00336
NW-200(10")	253	24.5	M8*24	231.8	SDA-00337
NW-250(12")	305	26	M8*32	284	SDA-00338
NW-300(14")	355	28.45	10.49*30	325.37	SDA-00339
NW-350(16.5")	418	28.45	10.49*36	388.76	SDA-00340

CF Bored flange with through holes

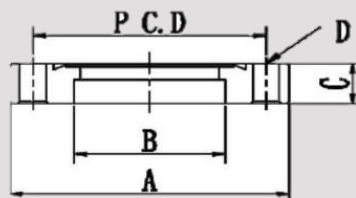
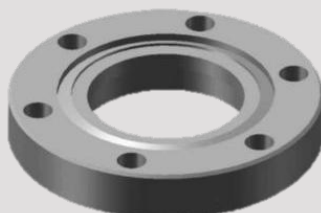

Material: 304 / 304L / 316 / 316L / 316LN

Model No.	A	B	C	D*No	P.C.D	Part No.
NW-16B19	34	19.2	7.3	4.4*6	27	SDA-00341
NW-25B25	54	25.6	10.5	6.7*4	43	SDA-00342
NW-25B28	54	28.2	10.5	6.7*4	43	SDA-00343
NW-35B25	70	25.6	13	6.7*6	58.7	SDA-00344
NW-35B38	70	38.3	13	6.7*6	58.7	SDA-00345
NW-35B45	70	45.2	13	6.7*6	58.7	SDA-00346
NW-50B51	86	51.1	16	8.4*8	72.4	SDA-00347
ISO-63B63	114	63.7	17.5	8.4*8	92.2	SDA-00348
ISO-80B76	117	76.2	19	8.4*16	102.4	SDA-00349
ISO-100B102	152	101.8	20	8.4*16	130.3	SDA-00350
ISO-160B153	202	153	22	8.4*20	181	SDA-00351
ISO-200B204	253	204.5	24.5	8.4*24	231.8	SDA-00352
ISO-250B254	305	254.6	26	8.4*32	284	SDA-00353

CF Bored flange with threaded holes

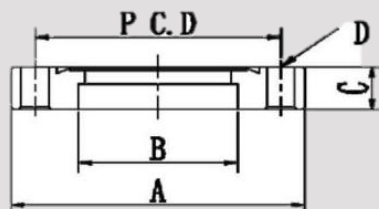

Material: 304 / 304L / 316 / 316L / 316LN

Model No.	A	B	C	D*No	P.C.D	Part No.
NW-16B19	34	19.2	7.3	M4*6	27	SDA-00353
NW-25B25	54	25.6	10.5	M6*4	43	SDA-00354
NW-25B28	54	28.2	10.5	M6*4	43	SDA-00355
NW-35B25	70	25.6	13	M6*6	58.7	SDA-00356
NW-35B38	70	38.3	13	M6*6	58.7	SDA-00357
NW-35B45	70	45.2	13	M6*6	58.7	SDA-00358
NW-50B51	86	51.1	16	M8*8	72.4	SDA-00359
ISO-63B63	114	63.7	17.5	M8*8	92.2	SDA-00360
ISO-80B76	117	76.2	19	M8*16	102.4	SDA-00361
ISO-100B102	152	101.8	20	M8*16	130.3	SDA-00362
ISO-160B153	202	153	22	M8*20	181	SDA-00363
ISO-200B204	253	204.5	24.5	M8*24	231.8	SDA-00364
ISO-250B254	305	254.6	26	M8*32	284	SDA-00365

CF rotatable blank flange with through holes

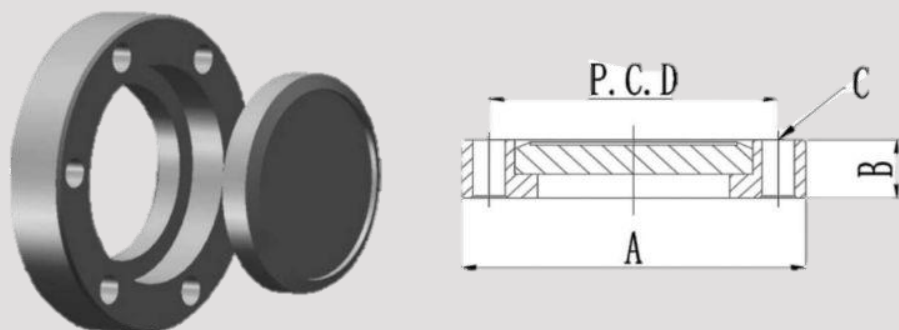

Material: 304 / 304L / 316 / 316L / 316LN

Model No.	A	B	C*No	P.C.D	Part No.
NW-16	34	7.3	4.4*6	27	SDA-00366
NW-25	54	10.5	6.7*4	43	SDA-00367
NW-35	70	13	6.7*6	58.7	SDA-00368
NW-50	86	16	8.4*8	72.4	SDA-00369
ISO-63	114	17.5	8.4*8	92.2	SDA-00370
ISO-80	117	19	8.4*16	102.4	SDA-00371
ISO-100	152	20	8.4*16	130.3	SDA-00372
ISO-160	202	22	8.4*20	181	SDA-00373
ISO-200	253	24.5	8.4*24	231	SDA-00374
ISO-250	305	26	8.4*32	284	SDA-00375

CF rotatable blank flange with thread holes

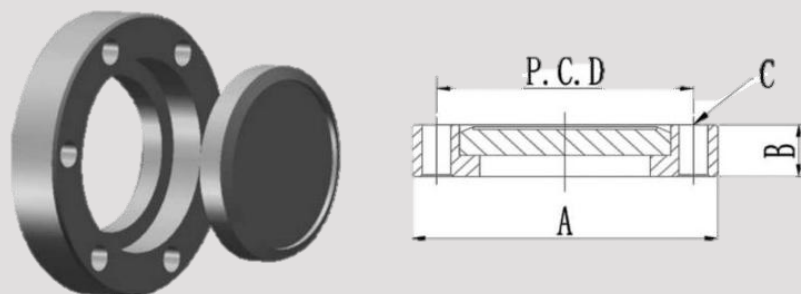

Material: 304 / 304L / 316 / 316L / 316LN

Model No.	A	B	C*No	P.C.D	Part No.
NW-16	34	7.3	M4*6	27	SDA-00376
NW-25	54	10.5	M6*4	43	SDA-00377
NW-35	70	13	M6*6	58.7	SDA-00378
NW-50	86	16	M8*8	72.4	SDA-00379
ISO-63	114	17.5	M8*8	92.2	SDA-00380
ISO-80	117	19	M8*16	102.4	SDA-00381
ISO-100	152	20	M8*16	130.3	SDA-00382
ISO-160	202	22	M8*20	181	SDA-00383
ISO-200	253	24.5	M8*24	231.8	SDA-00384
ISO-250	305	26	M8*32	284	SDA-00385

CF Rotatable bored flange with through holes

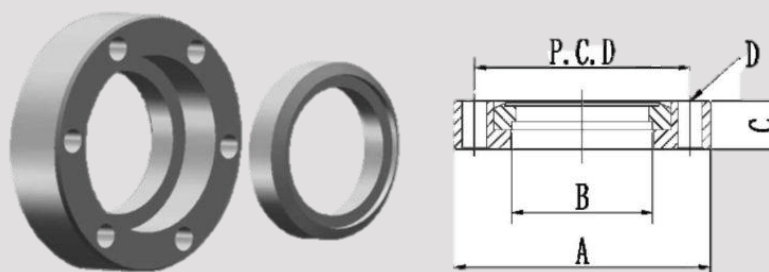

Material: 304 / 304L / 316 / 316L / 316LN

Model No.	A	B	C	D*No	P.C.D	Part No.
NW-16B19	34	19.2	7.3	4.4*6	27	SDA-00386
NW-25B25	54	25.6	10.5	6.7*4	43	SDA-00387
NW-25B28	54	28.2	10.5	6.7*4	43	SDA-00388
NW-35B25	70	25.6	13	6.7*6	58.7	SDA-00389
NW-35B38	70	38.3	13	6.7*6	58.7	SDA-00390
NW-35B45	70	45.2	13	6.7*6	58.7	SDA-00391
NW-50B51	86	51.1	16	8.4*8	72.4	SDA-00392
ISO-63B63	114	63.7	17.5	8.4*8	92.2	SDA-00393
ISO-80B76	117	76.2	19	8.4*16	102.4	SDA-00394
ISO-100B102	152	101.8	20	8.4*16	130.3	SDA-00395
ISO-160B153	202	153	22	8.4*20	181	SDA-00396
ISO-200B204	253	204.5	24.5	8.4*24	231.8	SDA-00397
ISO-250B254	305	254.6	26	8.4*32	284	SDA-00398

CF Rotatable bored flange with threaded holes

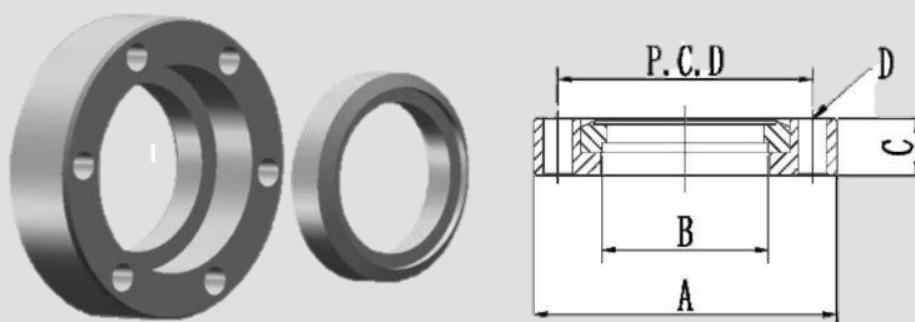

Material: 304 / 304L / 316 / 316L / 316LN

Model No.	A	B	C	D*No	P.C.D	Part No.
NW-16B19	34	19.2	7.3	M4*6	27	SDA-00399
NW-25B25	54	25.6	10.5	M6*6	43	SDA-00400
NW-25B28	54	28.2	10.5	M6*6	43	SDA-00401
NW-35B25	70	25.6	13	M6*6	58.7	SDA-00402
NW-35B38	70	38.3	13	M6*6	58.7	SDA-00403
NW-35B45	70	45.2	13	M6*6	58.7	SDA-00404
NW-50B51	86	51.1	16	M8*8	72.4	SDA-00405
ISO-63B63	114	63.7	17.5	M8*8	92.2	SDA-00406
ISO-80B76	117	76.2	19	M8*16	102.4	SDA-00407
ISO-100B102	152	101.8	20	M8*16	130.3	SDA-00408
ISO-160B153	202	153	22	M8*20	181	SDA-00409
ISO-200B204	253	204.5	24.5	M8*24	231.8	SDA-00410
ISO-250B254	305	254.6	26	M8*32	284	SDA-00411



CONTACT

 (+972)53-938-9696

 www.sda-tech.co.il

 office@sda-tech.com

 המסגר 9, מגדל העמק, ישראל

CF zero length Reducer

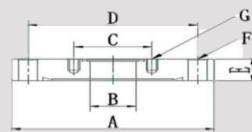
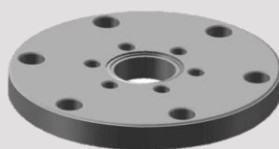

Material: 304 / 304L / 316 / 316L / 316LN

Model No.	A	B	C	D	E	F*No	G*No	Part No.
NW-25*16	54	16	27	43	10.5	6.7*4	M4*6	SDA-00412
NW-35*16	70	16	27	58.7	13	6.7*6	M4*6	SDA-00413
NW-35*25	70	25	43	58.7	13	6.7*6	M6*4	SDA-00414
NW-50*16	86	16	27	86	16	8.4*8	M4*6	SDA-00415
NW-50*25	86	25	43	86	16	8.4*8	M6*4	SDA-00416
NW-50*35	86	35	58.7	86	16	8.4*8	M6*6	SDA-00417
NW-63*35	114	35	58.7	92.2	17.5	8.4*8	M6*6	SDA-00418
NW-100*35	152	35	58.7	130.3	20	8.4*16	M6*6	SDA-00419
NW-100*63	152	63	92.2	130.3	20	8.4*16	M8*8	SDA-00420
NW-160*35	202	35	58.7	181	22	8.4*20	M6*6	SDA-00421
NW-160*63	202	63	92.2	181	22	8.4*20	M8*8	SDA-00422
NW-160*100	202	100	130.3	181	22	8.4*20	M8*16	SDA-00423
NW-200*35	253	35	58.7	231.8	24.5	8.4*24	M6*6	SDA-00424
NW-200*63	253	63	92.2	231.8	24.5	8.4*24	M8*8	SDA-00425
NW-200*100	253	100	130.3	231.8	24.5	8.4*24	M8*16	SDA-00426
NW-200*160	253	160	181	231.8	24.5	8.4*24	M8*20	SDA-00427
NW-250*35	305	35	58.7	284	26	8.4*32	M6*6	SDA-00428
NW-250*63	305	63	92.2	284	26	8.4*32	M8*8	SDA-00429
NW-250*100	305	100	130.3	284	26	8.4*32	M8*16	SDA-00430
NW-250*160	305	160	181	284	26	8.4*32	M8*20	SDA-00431
NW-250*200	305	200	231.8	284	26	8.4*32	M8*24	SDA-00432

CF Half nipple

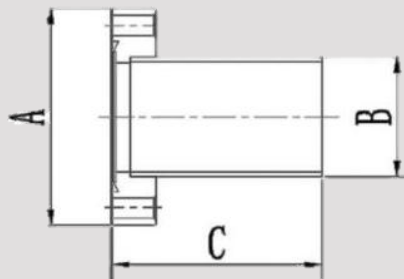

Material: 304 / 304L / 316 / 316L / 316LN

Model No.	A	B	C	Part No.
NW-16	34	19.05	38	SDA-00432
NW-25	54	25.4	52	SDA-00433
NW-35	70	38.1	63	SDA-00434
NW-50	86	50.8	82	SDA-00435
ISO-63	114	63.5	85	SDA-00436
ISO-80	117	76.2	90	SDA-00437
ISO-100	152	101.6	110	SDA-00438
ISO-160	202	152.4	140	SDA-00439
ISO-200	253	204	203	SDA-00440
ISO-250	305	254	250	SDA-00441

CF Rotatable half nipple

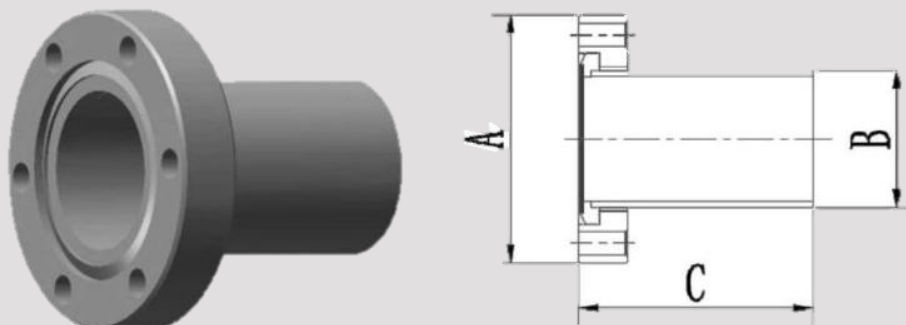

Material: 304 / 304L / 316 / 316L / 316LN

Model No.	A	B	C	Part No.
NW-16	34	19.05	38	SDA-00442
NW-25	54	25.4	52	SDA-00443
NW-35	70	38.1	63	SDA-00444
NW-50	86	50.8	82	SDA-00445
ISO-63	114	63.5	85	SDA-00446
ISO-80	117	76.2	90	SDA-00447
ISO-100	152	101.6	110	SDA-00448
ISO-160	202	152.4	140	SDA-00449
ISO-200	253	204	203	SDA-00450
ISO-250	305	254	250	SDA-00451

CF OFHC copper gasket

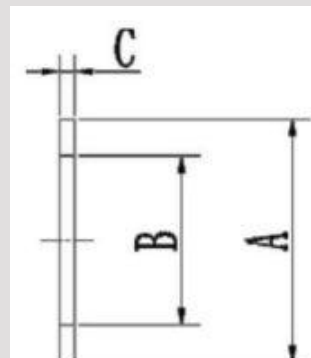
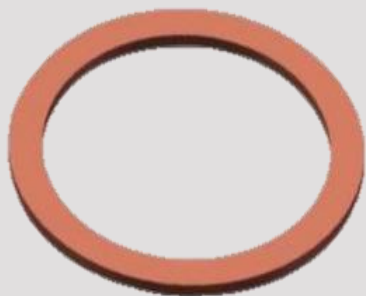

Material: OFHC TU2

TU2 with silver coated available on request.

Model No.	A	B	C	Part No.
NW-16	21.3	16.3	2.2	SDA-00452
NW-25	35	25.6	2.2	SDA-00453
NW-35	48.2	39	2.2	SDA-00454
NW-50	61.6	52	2.2	SDA-00455
ISO-63	82.4	63.8	2.2	SDA-00456
ISO-80	91.39	76.45	2.2	SDA-00457
ISO-100	120.5	102	2.2	SDA-00458
ISO-160	171.3	152.8	2.2	SDA-00459
ISO-200	222.1	203.6	2.2	SDA-00460
ISO-250	272.7	254	2.2	SDA-00461
ISO-300	313	300	2.2	SDA-00462
ISO-350	376.6	356.5	2.2	SDA-00463

CF OFHC copper gasket silver plated

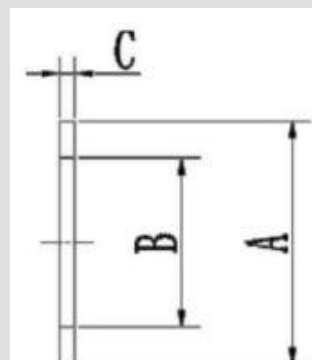

Material: OFHC TU2 silver coated

Model No.	A	B	C	Part No.
NW-16	21.3	16.3	2.2	SDA-00464
NW-25	35	25.6	2.2	SDA-00465
NW-35	48.2	39	2.2	SDA-00466
NW-50	61.6	52	2.2	SDA-00467
ISO-63	82.4	63.8	2.2	SDA-00468
ISO-80	91.39	76.45	2.2	SDA-00469
ISO-100	120.5	102	2.2	SDA-00470
ISO-160	171.3	152.8	2.2	SDA-00471
ISO-200	222.1	203.6	2.2	SDA-00472
ISO-250	272.7	254	2.2	SDA-00464
ISO-300	313	300	2.2	SDA-00465
ISO-350	376.6	356.5	2.2	SDA-00466



CONTACT 

 (+972)53-938-9696

 www.sda-tech.co.il

 office@sda-tech.com

 המסגר 9, מגדל העמק, ישראל

Bellows *and hoses*



עמוד 50 מתוך 183



CONTACT

 (+972)53-938-9696

 www.sda-tech.co.il

 office@sda-tech.com

 המסגר 9, מגדל העמק, ישראל

General Information

Metal bellows are key components in many sensing, sealing, fluid handling and actuation applications. Different manufacturing methods and material quality have significant effects on reliable performance in terms of stroke, pressure characteristics, spring rate and temperature response.

Formed Bellow: 316LS.S/304S.S (316L/304 Austenite Material)

Fittings: 316LS.S/304S.S (316L/304 Austenite Material)

Helium Leak Rate $\leq 1 \cdot 10^{-9}$ PaM³ /Sec

Repetition life $\geq 1 \cdot 10^4$ Repetitions

Working temperature $\leq 250^\circ\text{C}$

Feature

Hydraulic pressure Offers higher precision than roll forming.

Prevent disparity in stress.

Provides uniform quality for mass continuous production.

Can produce largely length products (Max : 10Meter)

Low-cost

Special Sizes Available Upon request

Flexible hose compressibility

מפוחי מתכת מחומר 316 304L באיכות גבוהה, לאיטום, חישה והפעלה עד 250°C , בעלי דיוק הידראולי, קצב דליפה נמוך, אורך חיים גבוה והתאמה למידות מיוחדות.



CONTACT

 (+972)53-938-9696

 www.sda-tech.co.il

 office@sda-tech.com

 המסגר 9, מגדל העמק, ישראל

Normal Dia	ID	O. D	Thickness	Pich	Compressibility of range of L	Material
16A	16.2	24	0.15	3	17.50%	304/316L
25A	25	36	0.15	3.7	23.60%	304/316L
40A	39.8	54	0.15	4.5	30.70%	304/316L
50A	49	65.5	0.15	5	35.80%	304/316L
65A	63	85	0.2	5.2	40.30%	304/316L
80A	79.6	102	0.2	5.4	39.40%	304/316L
100A	100.3	126	0.2	6.5	42.40%	304/316L
150A	149	176	0.25	7.5	33.60%	304/316L

NW/KF bellows



Material: 304,316L Remark: Length could be customized within 10m.

Model No.	A	B	Bellow thickness	Part No.
NW16-100L	30	100	0.2	SDA-00467
NW16-150L	30	150	0.2	SDA-00468
NW16-200L	30	200	0.2	SDA-00469
NW16-250L	30	250	0.2	SDA-00470
NW16-300L	30	300	0.2	SDA-00471
NW16-500L	30	500	0.2	SDA-00472
NW16-800L	30	800	0.2	SDA-00473
NW16-1000L	30	1000	0.2	SDA-00474
NW16-1200L	30	1200	0.2	SDA-00475
NW16-1500L	30	1500	0.2	SDA-00476
NW16-1800L	30	1800	0.2	SDA-00477



CONTACT

 (+972)53-938-9696

 www.sda-tech.co.il

 office@sda-tech.com

 המסגר 9, מגדל העמק, ישראל

NW16-2000L	30	2000	0.2	SDA-00478
NW25-100L	40	100	0.2	SDA-00479
NW25-150L	40	150	0.2	SDA-00480
NW25-200L	40	200	0.2	SDA-00481
NW25-250L	40	250	0.2	SDA-00482
NW25-300L	40	300	0.2	SDA-00483
NW25-500L	40	500	0.2	SDA-00484
NW25-800L	40	800	0.2	SDA-00485
NW25-1000L	40	1000	0.2	SDA-00486
NW25-1200L	40	1200	0.2	SDA-00487
NW25-1500L	40	1500	0.2	SDA-00488
NW25-1800L	40	1800	0.2	SDA-00489
NW25-2000L	40	2000	0.2	SDA-00490
NW40-100L	55	100	0.25	SDA-00491
NW40-150L	55	150	0.25	SDA-00492
NW40-200L	55	200	0.25	SDA-00493
NW40-250L	55	250	0.25	SDA-00494
NW40-300L	55	300	0.25	SDA-00495
NW40-500L	55	500	0.25	SDA-00496
NW40-800L	55	800	0.25	SDA-00497
NW40-1000L	55	1000	0.25	SDA-00498
NW40-1200L	55	1200	0.25	SDA-00499
NW40-1500L	55	1500	0.25	SDA-00500
NW40-1800L	55	1800	0.25	SDA-00501
NW40-2000L	55	2000	0.25	SDA-00502
NW50-100L	75	100	0.25	SDA-00503
NW50-150L	75	150	0.25	SDA-00504
NW50-200L	75	200	0.25	SDA-00505
NW50-250L	75	250	0.25	SDA-00506
NW50-300L	75	300	0.25	SDA-00507



CONTACT

 (+972)53-938-9696

 www.sda-tech.co.il

 office@sda-tech.com

 המסגר 9, מגדל העמק, ישראל

NW50-500L	75	500	0.25	SDA-00508
NW50-800L	75	800	0.25	SDA-00509
NW50-1000L	75	1000	0.25	SDA-00510
NW50-1200L	75	1200	0.25	SDA-00511
NW50-1500L	75	1500	0.25	SDA-00512
NW50-1800L	75	1800	0.25	SDA-00513
NW50-2000L	75	2000	0.25	SDA-00514

ISO bellows

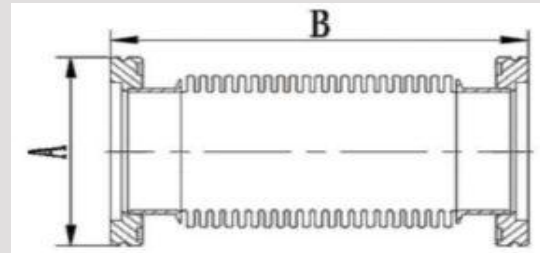

Material: 304,316L

Remark: Length could be customized within 3m.

Model No.	A	B	Bellow thickness	Part No.
ISO63-100L	95	100	0.25	SDA-00515
ISO63-150L	95	150	0.25	SDA-00516
ISO63-200L	95	200	0.25	SDA-00517
ISO63-250L	95	250	0.25	SDA-00518
ISO63-300L	95	300	0.25	SDA-00519
ISO63-400L	95	400	0.25	SDA-00520
ISO63-500L	95	500	0.25	SDA-00521
ISO63-800L	95	800	0.25	SDA-00522



CONTACT

 (+972)53-938-9696

 www.sda-tech.co.il

 office@sda-tech.com

 המסגר 9, מגדל העמק, ישראל

ISO63-1000L	95	1000	0.25	SDA-00523
ISO80-100L	110	100	0.25	SDA-00524
ISO80-150L	110	150	0.25	SDA-00525
ISO80-200L	110	200	0.25	SDA-00526
ISO80-250L	110	250	0.25	SDA-00527
ISO80-300L	110	300	0.25	SDA-00528
ISO80-400L	110	400	0.25	SDA-00529
ISO80-500L	110	500	0.25	SDA-00530
ISO80-800L	110	800	0.25	SDA-00531
ISO80-1000L	110	1000	0.25	SDA-00532
ISO100-100L	130	100	0.25	SDA-00533
ISO100-150L	130	150	0.25	SDA-00534
ISO100-200L	130	200	0.25	SDA-00535
ISO100-250L	130	250	0.25	SDA-00536
ISO100-300L	130	300	0.25	SDA-00537
ISO100-400L	130	400	0.25	SDA-00538
ISO100-500L	130	500	0.25	SDA-00539
ISO100-800L	130	800	0.25	SDA-00540
ISO100-1000L	130	1000	0.25	SDA-00541
ISO160-100L	180	100	0.25	SDA-00542
ISO160-150L	180	150	0.25	SDA-00543
ISO160-200L	180	200	0.25	SDA-00544
ISO160-250L	180	250	0.25	SDA-00545
ISO160-300L	180	300	0.25	SDA-00546
ISO160-400L	180	400	0.25	SDA-00547
ISO160-500L	180	500	0.25	SDA-00548



CONTACT

 (+972)53-938-9696

 www.sda-tech.co.il

 office@sda-tech.com

 המסגר 9, מגדל העמק, ישראל

ISO160-800L	180	800	0.25	SDA-00549
ISO160-1000L	180	1000	0.25	SDA-00550
ISO200-100L	240	100	0.25	SDA-00551
ISO200-150L	240	150	0.25	SDA-00552
ISO200-200L	240	200	0.25	SDA-00553
ISO200-250L	240	250	0.25	SDA-00554
ISO200-300L	240	300	0.25	SDA-00555
ISO200-400L	240	400	0.25	SDA-00556
ISO200-500L	240	500	0.25	SDA-00557
ISO200-800L	240	800	0.25	SDA-00558
ISO200-1000L	240	1000	0.25	SDA-00559
ISO250-100L	290	100	0.25	SDA-00560
ISO250-150L	290	150	0.25	SDA-00561
ISO250-200L	290	200	0.25	SDA-00562
ISO250-250L	290	250	0.25	SDA-00563
ISO250-300L	290	300	0.25	SDA-00564
ISO250-400L	290	400	0.25	SDA-00565
ISO250-500L	290	500	0.25	SDA-00566
ISO250-800L	290	800	0.25	SDA-00567
ISO250-1000L	290	1000	0.25	SDA-00568



CONTACT

 (+972)53-938-9696

 www.sda-tech.co.il

 office@sda-tech.com

 המסגר 9, מגדל העמק, ישראל



NW/CF bellows

Material: 304,316L

Remark: Length could be customized within 3m.

Flanges could be fixed and rotatable based on request.

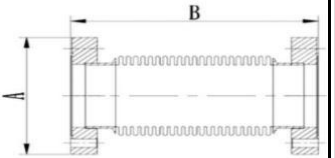

Model No.	A	B	Bellow thickness	Part No.
NW16-300L	34	300	0.2	SDA-00569
NW16-500L	34	500	0.2	SDA-00570
NW16-750L	34	750	0.2	SDA-00571
NW16-1000L	34	1000	0.2	SDA-00572
NW25-300L	54	300	0.2	SDA-00573
NW25-500L	54	500	0.2	SDA-00574
NW25-750L	54	750	0.2	SDA-00575
NW25-1000L	54	1000	0.2	SDA-00576
NW35-300L	70	300	0.2	SDA-00577
NW35-500L	70	500	0.2	SDA-00578
NW35-750L	70	750	0.2	SDA-00579
NW35-1000L	70	1000	0.2	SDA-00580
NW50-300L	86	300	0.25	SDA-00581
NW50-500L	86	500	0.25	SDA-00582
NW50-750L	86	750	0.25	SDA-00583
NW50-1000L	86	1000	0.25	SDA-00584
NW63-300L	114	300	0.25	SDA-00585
NW63-500L	114	500	0.25	SDA-00586
NW63-750L	114	750	0.25	SDA-00587
NW63-1000L	114	1000	0.25	SDA-00588



CONTACT

 (+972)53-938-9696

 www.sda-tech.co.il

 office@sda-tech.com

 המסגר 9, מגדל העמק, ישראל

NW/KF Flexible hoses

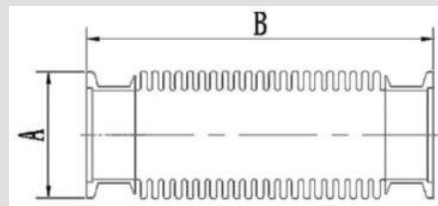
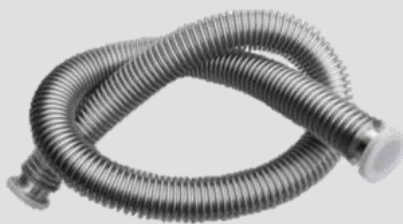

Material: 304,316L

Remark: Length could be customized within 3m.

Model No.	A	B	Hose thickness	Part No.
NW16-100L	30	100	0.15	SDA-00589
NW16-150L	30	150	0.15	SDA-00590
NW16-200L	30	200	0.15	SDA-00591
NW16-250L	30	250	0.15	SDA-00592
NW16-300L	30	300	0.15	SDA-00593
NW16-400L	30	400	0.15	SDA-00594
NW16-500L	30	500	0.15	SDA-00595
NW16-800L	30	800	0.15	SDA-00596
NW16-1000L	30	1000	0.15	SDA-00597
NW25-100L	40	100	0.15	SDA-00598
NW25-150L	40	150	0.15	SDA-00599
NW25-200L	40	200	0.15	SDA-00600
NW25-250L	40	250	0.15	SDA-00601
NW25-300L	40	300	0.15	SDA-00602
NW25-400L	40	400	0.15	SDA-00603
NW25-500L	40	500	0.15	SDA-00604
NW25-800L	40	800	0.15	SDA-00605
NW25-1000L	40	1000	0.15	SDA-00606



CONTACT

 (+972)53-938-9696

 www.sda-tech.co.il

 office@sda-tech.com

 המסגר 9, מגדל העמק, ישראל

NW40-100L	55	100	0.2	SDA-00607
NW40-150L	55	150	0.2	SDA-00608
NW40-200L	55	200	0.2	SDA-00609
NW40-250L	55	250	0.2	SDA-00610
NW40-300L	55	300	0.2	SDA-00611
NW40-400L	55	400	0.2	SDA-00612
NW40-500L	55	500	0.2	SDA-00613
NW40-800L	55	800	0.2	SDA-00614
NW40-1000L	55	1000	0.2	SDA-00615
NW50-100L	75	100	0.2	SDA-00616
NW50-150L	75	150	0.2	SDA-00617
NW50-200L	75	200	0.2	SDA-00618
NW50-250L	75	250	0.2	SDA-00619
NW50-300L	75	300	0.2	SDA-00620
NW50-400L	75	400	0.2	SDA-00621
NW50-500L	75	500	0.2	SDA-00622
NW50-800L	75	800	0.2	SDA-00623
NW50-1000L	75	1000	0.2	SDA-00624



CONTACT

 (+972)53-938-9696

 www.sda-tech.co.il

 office@sda-tech.com

 המסגר 9, מגדל העמק, ישראל

ISO Flexible hoses

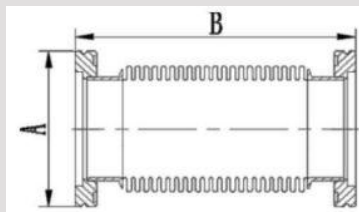

Material: 304,316L

Remark: Length could be customized within 3m.

Model No.	A	B	Hose thickness	Part No.
ISO63-100L	95	100	0.2	SDA-00603
ISO63-150L	95	150	0.2	SDA-00604
ISO63-200L	95	200	0.2	SDA-00605
ISO63-250L	95	250	0.2	SDA-00606
ISO63-300L	95	300	0.2	SDA-00607
ISO63-400L	95	400	0.2	SDA-00608
ISO63-500L	95	500	0.2	SDA-00609
ISO80-100L	110	100	0.2	SDA-00610
ISO80-150L	110	150	0.2	SDA-00611
ISO80-200L	110	200	0.2	SDA-00612
ISO80-250L	110	250	0.2	SDA-00613
ISO80-300L	110	300	0.2	SDA-00614
ISO80-400L	110	400	0.2	SDA-00615
ISO80-500L	110	500	0.2	SDA-00616
ISO100-100L	130	100	0.2	SDA-00617
ISO100-150L	130	150	0.2	SDA-00618



CONTACT

 (+972)53-938-9696

 www.sda-tech.co.il

 office@sda-tech.com

 המסגר 9, מגדל העמק, ישראל

ISO100-200L	130	200	0.2	SDA-00619
ISO100-250L	130	250	0.2	SDA-00620
ISO100-300L	130	300	0.2	SDA-00621
ISO100-400L	130	400	0.2	SDA-00622
ISO100-500L	130	500	0.2	SDA-00623
ISO160-100L	180	100	0.2	SDA-00624
ISO160-150L	180	150	0.2	SDA-00625
ISO160-200L	180	200	0.2	SDA-00626
ISO160-250L	180	250	0.2	SDA-00627
ISO160-300L	180	300	0.2	SDA-00628
ISO160-400L	180	400	0.2	SDA-00629
ISO160-500L	180	500	0.2	SDA-00630
ISO200-100L	240	100	0.2	SDA-00631
ISO200-150L	240	150	0.2	SDA-00632
ISO200-200L	240	200	0.2	SDA-00633
ISO200-250L	240	250	0.2	SDA-00634
ISO200-300L	240	300	0.2	SDA-00635
ISO200-400L	240	400	0.2	SDA-00636
ISO200-500L	240	500	0.2	SDA-00637
ISO250-100L	290	100	0.2	SDA-00638
ISO250-150L	290	150	0.2	SDA-00639
ISO250-200L	290	200	0.2	SDA-00640
ISO250-250L	290	250	0.2	SDA-00641
ISO250-300L	290	300	0.2	SDA-00642
ISO250-400L	290	400	0.2	SDA-00643
ISO250-500L	290	500	0.2	SDA-00644

CF Flexible hoses

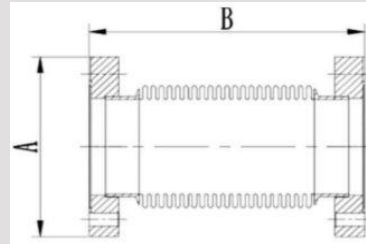

Material: 304,316L

Remark: Length could be customized within 3m.

Flanges could be fixed and rotatable based on request.

Model No.	A	B	Hose thickness	Part No.
CF16	34	Length is available at any within 3m.	0.15	SDA-00645
CF25	54		0.15	SDA-00646
CF35	70		0.15	SDA-00647
CF50	86		0.2	SDA-00648
CF63	114		0.2	SDA-00649
			0.2	SDA-00650
CF80	130		0.2	SDA-00651
CF100	152		0.2	SDA-00652
CF160	202		0.2	SDA-00653
CF200	253		0.2	SDA-00654
CF250	305		0.2	SDA-00655



CONTACT

 (+972)53-938-9696

 www.sda-tech.co.il

 office@sda-tech.com

 המסגר 9, מגדל העמק, ישראל

NW/KF Bellows with braided mesh

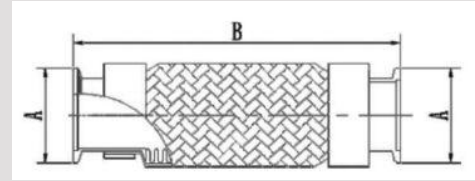

Material: 304,316L

Remark: Length could be customized within 10m.

Model No.	A	B	Part No.
NW16	30	Length is available at any within 10m	SDA-00665
NW25	40		SDA-00666
NW40	55		SDA-00667
NW50	75		SDA-00668



CONTACT

 (+972)53-938-9696

 www.sda-tech.co.il

 office@sda-tech.com

 המסגר 9, מגדל העמק, ישראל

ISO-F bellows

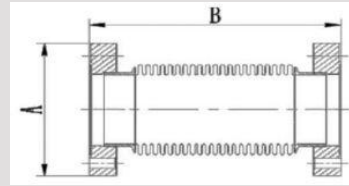

Material: 304,316L

Remark: Length could be customized within 3m.

Model No.	A	B	Part No.
ISO16F	60	Length is available at any within 3m.	SDA-00656
ISO25F	70		SDA-00657
ISO40F	100		SDA-00658
ISO50F	110	Length is available at any within 3m.	SDA-00659
ISO63F	130		SDA-00660
ISO80F	145		SDA-00661
ISO100F	165		SDA-00662
ISO160F	225		SDA-00663
ISO200F	285		SDA-00664

ISO-F bellow with braided mesh

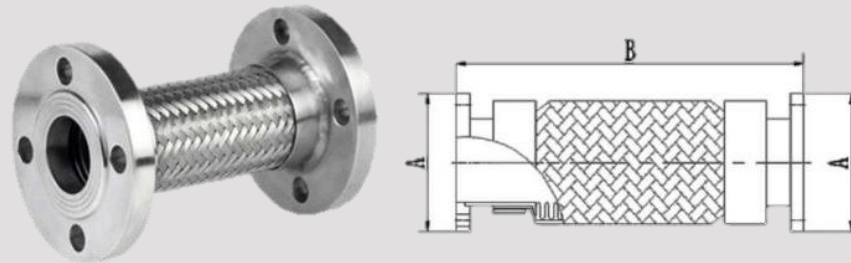

Material: 304,316L

Remark: Length could be customized within 3m.

Model No.	A	B	Part No.
ISOFFX16	60	Length is available at any within 3m	SDA-00669
ISOFFX25	70		SDA-00670
ISOFFX40	100		SDA-00671
ISOFFX50	110		SDA-00672
ISOFFX63	130		SDA-00673
ISOFFX80	145		SDA-00674
ISOFFX100	165		SDA-00675
ISOFFX160	225		SDA-00676
ISOFFX200	285		SDA-00677
ISOFFX250	335		SDA-00678
ISOFFX320	425		SDA-00679

Ferrule and VCR bellows

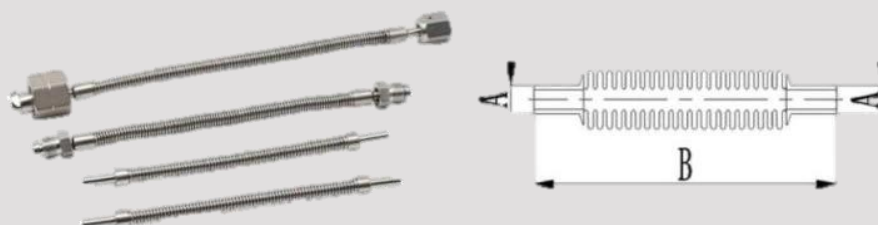

Material: 304,316L

Remark: Length could be customized within 20m.

Model No.	A	B	Part No.
KT3FX	3	Length is available at any within 20m. Connecting flange could be quick type or VCR type.	SDA-00680
KT4FX	4		SDA-00681
KT6FX	6		SDA-00682
KT8FX	8		SDA-00683
KT10FX	10		SDA-00684
KT12FX	12		SDA-00685
KT03FX	3.18		SDA-00686
KT06FX	6.35		SDA-00687
KT09FX	9.53		SDA-00688
KT12FX	12.7		SDA-00689

Ferrule and VCR bellows with braided mesh

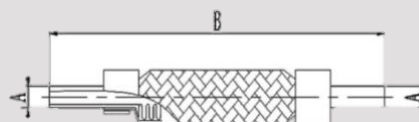

Material: 304,316L

Remark: Length could be customized within 20m.

Model No.	A	B	Part No.
KT3FXM	3	<p>Length is available at any within 20m.</p> <p>Connecting flange could be quick type or VCR type.</p>	SDA-00690
KT4FXM	4		SDA-00691
KT6FXM	6		SDA-00692
KT8FXM	8		SDA-00693
KT10FXM	10		SDA-00694
KT12FXM	12		SDA-00695
KT03FXM	3.18		SDA-00696
KT06FXM	6.35		SDA-00697
KT09FXM	9.53		SDA-00698
KT12FXM	12.7		SDA-00699



CONTACT

 (+972)53-938-9696

 www.sda-tech.co.il

 office@sda-tech.com

 המסגר 9, מגדל העמק, ישראל

SS pipe fittings





CONTACT

 (+972)53-938-9696

 www.sda-tech.co.il

 office@sda-tech.com

 המסגר 9, מגדל העמק, ישראל

The pipe fittings could be made according to different types of standards, including 3A, BPE, SMS, ISO based on buyers' requests. 304/304L grade is the standard, but 316/316L is available upon request.

Material test reports will be furnished upon request at the time of order.

All welding is done with cryogenic source inert gas welding methods.

used on tubing and fittings. Interior surfaces are smooth, even and uniform. Standard finish for fittings is Mill Finish, other finishes available upon request.

אביזרי הצנרת מיוצרים בהתאם לתקנים שונים (3A, BPE, SMS, ISO) לפי דרישת הלקוח.
חומר סטנדרטי: 304/304L, עם אפשרות ל-316/316L לפי בקשה.
דוחות בדיקת חומר יסופקו לפי דרישה בעת ההזמנה.
כל הריתוכים מבוצעים בגז אינרטי בתנאי קריוגניקה.
פני השטח הפנימיים חלקים ואחידים; הגימור הסטנדרטי הוא Mill Finish עם אפשרות לגימורים נוספים.

Welding Conical reducer

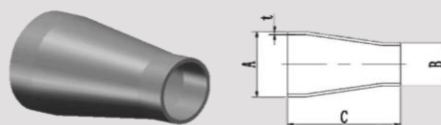

Material: 304,304L,316L

Finishing: Pickling, Tumbling, Sandblasting, Matt, Mirror

Model No.	A	B	C	t	Part No.
BW-CRN-100*075	25.4	19.05	35	1.65	SDA-00700
BW-CRN-150*075	38.1	19.05	60	1.65	SDA-00701
BW-CRN-150*100	38.1	25.4	60	1.65	SDA-00702
BW-CRN-200*100	50.8	25.4	60	1.65	SDA-00703
BW-CRN-200*150	50.8	38.1	60	1.65	SDA-00704
BW-CRN-250*150	63.5	38.1	60	1.65	SDA-00705
BW-CRN-250*200	63.5	50.8	60	1.65	SDA-00706
BW-CRN-300*200	76.2	50.8	90	1.65	SDA-00707
BW-CRN-300*250	76.2	63.5	90	1.65	SDA-00708
BW-CRN-400*200	101.6	50.8	90	2.11	SDA-00709
BW-CRN-400*250	101.6	63.5	90	2.11	SDA-00710
BW-CRN-400*300	101.6	76.2	90	2.11	SDA-00711
BW-CRN-600*300	152.4	76.2	152	2.8	SDA-00712
BW-CRN-600*400	152.4	101.6	152	2.8	SDA-00713

Welding 90° elbow

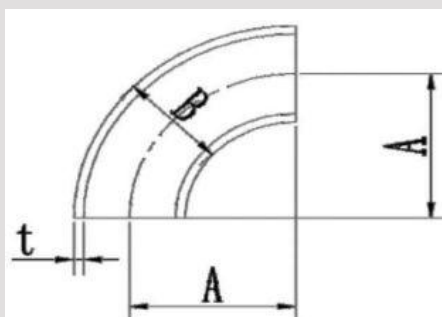

Material: 304,316L

Finishing: Pickling, Tumbling, Sandblasting, Matt, Mirror

Standard:3A Another standard could be supplied upon request.

Model No.	A	B	t	Part No.
BW-90EL-050	19.01	12.7	0.89	SDA-00714
BW-90EL-075	28.6	19.05	1.65	SDA-00715
BW-90EL-100	38.1	25.4	1.65	SDA-00716
BW-90EL-150	57.2	38.1	1.65	SDA-00717
BW-90EL-200	76.2	50.8	1.65	SDA-00718
BW-90EL-250	95.2	63.5	1.65	SDA-00719
BW-90EL-300	114.3	76.2	1.65	SDA-00720
BW-90EL-400	152.4	101.6	2.11	SDA-00721
BW-90EL-600	228.6	152.4	2.8	SDA-00722

Welding 90° elbow with tangents

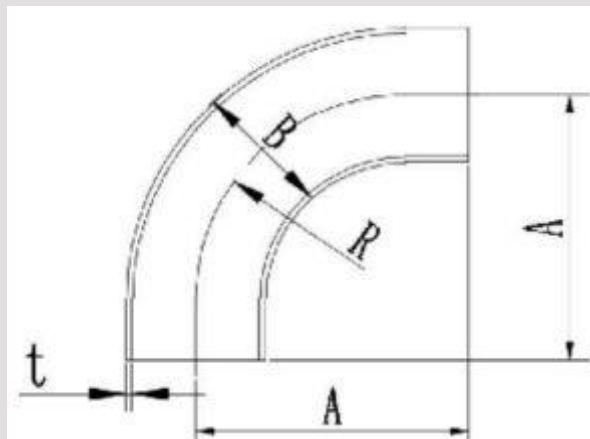

Material: 304,316L

Finishing: Pickling, Tumbling, Sandblasting, Matt, Mirror

Standard:3A Another standard could be supplied upon request.

Model No.	A	B	R	t	Part No.
BW-90ELT-075	34.5	19.05	28.6	1.65	SDA-00723
BW-90ELT-100	52.4	25.4	38.1	1.65	SDA-00724
BW-90ELT-150	74.6	38.1	57.2	1.65	SDA-00725
BW-90ELT-200	103.2	50.8	76.2	1.65	SDA-00726
BW-90ELT-250	131.8	63.5	95.2	1.65	SDA-00727
BW-90ELT-300	160.3	76.2	114.3	1.65	SDA-00728
BW-90ELT-400	211.1	101.6	152.4	2.11	SDA-00729



CONTACT

 (+972)53-938-9696

 office@sda-tech.com

 www.sda-tech.co.il

 המסגר 9, מגדל העמק, ישראל

Welding 45° elbow

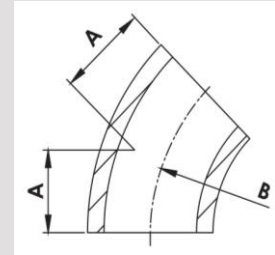

Material: 304,316L

Finishing: Pickling, Tumbling, Sandblasting, Matt, Mirror

Standard:3AOther standard could be supplied upon request.

Model No.	A	B	t	Part No.
BW-45EL-075	11.91	19.05	1.65	SDA-00730
BW-45EL-100	15.77	25.4	1.65	SDA-00731
BW-45EL-150	23.67	38.1	1.65	SDA-00732
BW-45EL-200	31.75	50.8	1.65	SDA-00733
BW-45EL-250	39.7	63.5	1.65	SDA-00734
BW-45EL-300	47.6	76.2	1.65	SDA-00735
BW-45EL-400	63.5	101.6	2.11	SDA-00736

Welding 45° elbow with tangents

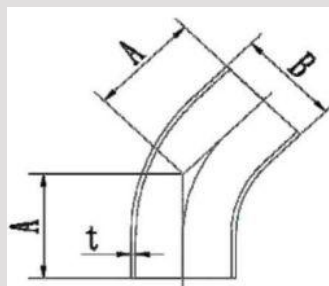
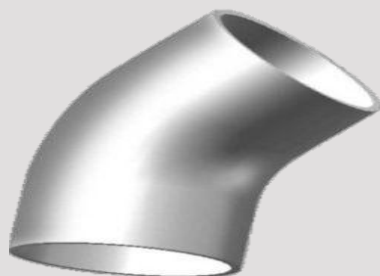

Material: 304,316L

Finishing: Pickling, Tumbling, Sandblasting, Matt, Mirror

Standard:3A other

standard could be supplied upon request.

Model No.	A	B	t	Part No.
BW-45ELT-075	19.3	19.05	1.65	SDA-00737
BW-45ELT-100	30.2	25.4	1.65	SDA-00738
BW-45ELT-150	41.3	38.1	1.65	SDA-00739
BW-45ELT-200	58.7	50.8	1.65	SDA-00740
BW-45ELT-250	76.2	63.5	1.65	SDA-00741
BW-45ELT-300	93.7	76.2	1.65	SDA-00742
BW-45ELT-400	122.2	101.6	2.11	SDA-00743



CONTACT

 (+972)53-938-9696

 www.sda-tech.co.il

 office@sda-tech.com

 המסגר 9, מגדל העמק, ישראל

Welding equal tee

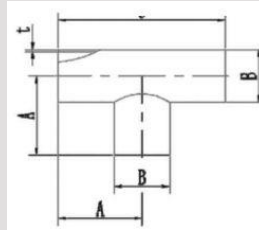

Material: 304,316L

Finishing: Pickling, Tumbling, Sandblasting, Matt, Mirror

Standard:3A other

standard could be supplied upon request.

Model No.	A	B	C	t	Part No.
BW-ET-075	34.5	19.05	69	1.65	SDA-00744
BW-ET-100	47.6	25.4	95.2	1.65	SDA-00745
BW-ET-150	57.2	38.1	114.4	1.65	SDA-00746
BW-ET-200	76.2	50.8	152.4	1.65	SDA-00747
BW-ET-250	76.2	63.5	152.4	1.65	SDA-00748
BW-ET-300	82.5	76.2	165.1	1.65	SDA-00749
BW-ET-400	98.4	101.6	196.8	2.11	SDA-00750
BW-ET-600	127	152.4	254	2.8	SDA-00751

Welding equal crosses

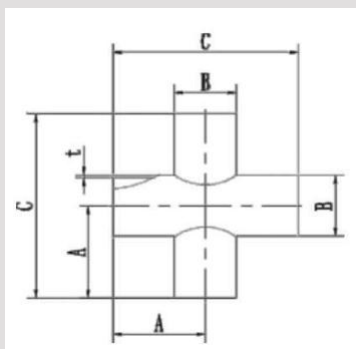

Material: 304,316L

Finishing: Pickling, Tumbling, Sandblasting, Matt, Mirror

Standard:3A Other standard could be supplied upon request.

Model No.	A	B	C	t	Part No.
BW-4C-075	34.5	19.05	69	1.65	SDA-00752
BW-4C-100	47.6	25.4	95.2	1.65	SDA-00753
BW-4C-150	57.2	38.1	114.4	1.65	SDA-00754
BW-4C-200	76.2	50.8	152.4	1.65	SDA-00755
BW-4C-250	76.2	63.5	152.4	1.65	SDA-00756
BW-4C-300	82.5	76.2	165.1	1.65	SDA-00757
BW-4C-400	98.4	101.6	196.8	2.11	SDA-00758
BW-4C-600	127	152.4	254	2.8	SDA-00759



CONTACT

 (+972)53-938-9696

 www.sda-tech.co.il

 office@sda-tech.com

 המסגר 9, מגדל העמק, ישראל

Reducing tee

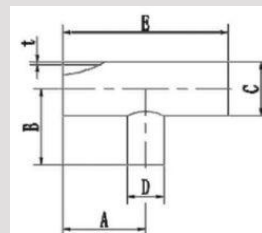
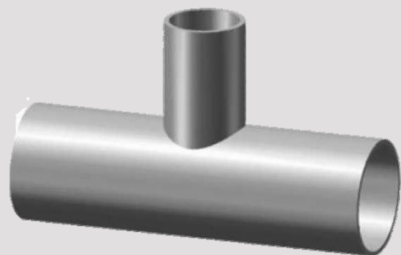

Material: 304,316L

Finishing: Pickling, Tumbling, Sandblasting, Matt, Mirror

Standard:3A other standard could be supplied upon request.

Model No.	A	B	C	D	E	t	Part No.
BW-RT-100*075	48.2	33.7	25.4	19.05	96.4	1.65	SDA-00760
BW-RT-150*075	57.2	48.2	38.1	19.05	114.4	1.65	SDA-00761
BW-RT-150*100	57.2	54	38.1	25.4	114.4	1.65	SDA-00762
BW-RT-200*075	76.2	54	50.8	19.05	152.4	1.65	SDA-00763
BW-RT-200*100	76.2	60	50.8	25.4	152.4	1.65	SDA-00764
BW-RT-200*150	76.2	63.5	50.8	38.1	152.4	1.65	SDA-00765
BW-RT-300*250	82.5	82.5	50.8	63.5	165	1.65	SDA-00766
BW-RT-400*200	98.4	95.3	101.6	50.8	196.8	2.11	SDA-00767
BW-RT-400*250	98.4	95.3	102.6	63.5	196.8	2.11	SDA-00768
BW-RT-400*300	98.4	95.3	103.6	76.2	196.8	2.11	SDA-00769
BW-RT-600*300	127	120.7	152.4	76.2	254	2.8	SDA-00770

Reducing crosses

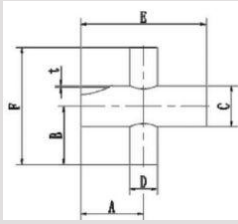

Material: 304,316L

Finishing: Pickling, Tumbling, Sandblasting, Matt,

Standard:3A other

standard could be supplied upon request.

Model No.	A	B	C	D	E	F	t	Part No.
BW-4RC-100*075	48.2	33.7	25.4	19.05	96.4	67.4	1.65	SDA-00771
BW-4RC-150*075	57.2	48.2	38.1	19.05	114.4	96.4	1.65	SDA-00772
BW-4RC-150*100	57.2	54	38.1	25.4	114.4	108	1.65	SDA-00773
BW-4RC-200*075	76.2	54	50.8	19.05	152.4	108	1.65	SDA-00774
BW-4RC-200*100	76.2	60	50.8	25.4	152.4	120	1.65	SDA-00775
BW-4RC-200*150	76.2	63.5	50.8	38.1	152.4	127	1.65	SDA-00776
BW-4RC-300*250	82.5	82.5	50.8	63.5	165	165	1.65	SDA-00777
BW-4RC-400*200	98.4	95.3	101.6	50.8	196.8	190.6	2.11	SDA-00778
BW-4RC-400*250	98.4	95.3	101.6	63.5	196.8	190.6	2.11	SDA-00779
BW-4RC-400*300	98.4	95.3	101.6	76.2	196.8	190.6	2.11	SDA-00780
BW-4RC-600*300	127	120.7	152.4	76.2	254	241.4	2.8	SDA-00781
BW-4RC-600*400	127	123.8	152.4	101.6	254	247.6	2.8	SDA-00782

Weld 90° mitered elbows.

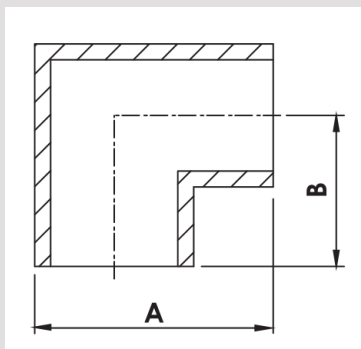

Material: 304,316L

Finishing: Pickling, Tumbling, Sandblasting, Matt, Mirror

Remark: Other sizes could be customized upon request.

Model No.	Tube OD	A	B	wall thickness	Part No.
BW-MEL-075	3/4"	34.93	25.4	1.65	SDA-00783
BW-MEL-100	1"	60.2	47.5	1.65	SDA-00784
BW-MEL-150	1 1/2"	76.2	57.15	1.65	SDA-00785
BW-MEL-200	2"	91.44	66.04	1.65	SDA-00786
BW-MEL-250	2 1/2"	107.95	76.2	1.65	SDA-00787
BW-MEL-300	3"	120.65	82.55	1.65	SDA-00788
BW-MEL-400	4"	149.35	98.55	2.11	SDA-00789
BW-MEL-600	6"	230.12	153.92	2.11	SDA-00790



CONTACT

 (+972)53-938-9696

 www.sda-tech.co.il

 office@sda-tech.com

 המסגר 9, מגדל העמק, ישראל

NW\KF 90° elbow

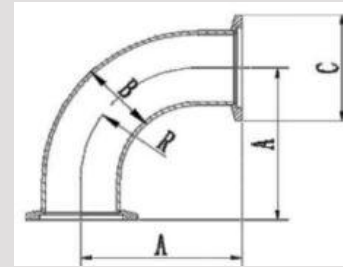

Material: 304, 316L

Finishing: Pickling, Tumbling, Sandblasting, Matt, Mirror

Remark: Other sizes could be customized upon request.

Model No.	Standard	A	B	C	T	R	Part No.
NW-90-10	3A	31.8	12.7	30	1.5	19.05	SDA-00791
NW-90-16	3A	32.1	19.05	30	1.65	28.6	SDA-00792
NW-90--25	3A	41.6	25.4	40	1.65	38.1	SDA-00793
NW-90-40	3A	60.7	38.1	55	1.65	57.2	SDA-00794
NW-90-50	3A	80	50.8	75	1.65	76.2	SDA-00795
NW-90-10	ISO	30	14	30	1.2	26.2	SDA-00796
NW-90-16	ISO	32.8	19	30	1.5	29	SDA-00797
NW-90--25	ISO	41	28	40	1.5	37.2	SDA-00798
NW-90-40	ISO	52.8	42	55	1.5	49	SDA-00799
NW-90-50	ISO	65.5	54	75	2	61.7	SDA-00800



CONTACT

 (+972)53-938-9696

 www.sda-tech.co.il

 office@sda-tech.com

 המסגר 9, מגדל העמק, ישראל

KF 90° Elbows with tangents

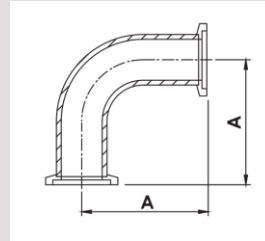

Material:304,316L

Finishing: Pickling, Tumbling, Sandblasting, Matt, Mirror

Model No.	Standard	A	Part No.
NW-90-16	3A	68.58	SDA-00801
NW-90-25	3A	92.46	SDA-00802
NW-90-40	3A	130.05	SDA-00803
NW-90-50	3A	139.95	SDA-00804



CONTACT

 (+972)53-938-9696

 www.sda-tech.co.il

 office@sda-tech.com

 המסגר 9, מגדל העמק, ישראל

NW/KF 45° elbow

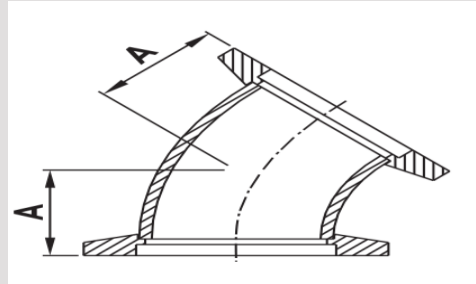

Material:304,316L

Finishing: Pickling, Tumbling, Sandblasting, Matt, Mirror

Remark: Other sizes could be customized upon request.

Model No.	Standard	A	Part No.
NW-45-16	3A	15.65	SDA-00805
NW-45-25	3A	19.58	SDA-00806
NW-45-40	3A	27.47	SDA-00807
NW-45-50	3A	35.36	SDA-00808

NW/KF 45° Elbows with tangents

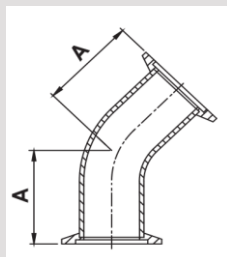

Material:304,316L

Finishing: Pickling, Tumbling, Sandblasting,
Matt, Mirror



Remark: Other sizes could be customized upon request.

Model No.	Standard	A	Part No.
NW-45-16	3A	23.1	SDA-00809
NW-45-25	3A	33.88	SDA-00810
MW-45-40	3A	45.1	SDA-00811
NW-45-50	3A	62.5	SDA-00812

NW/KF full nipple

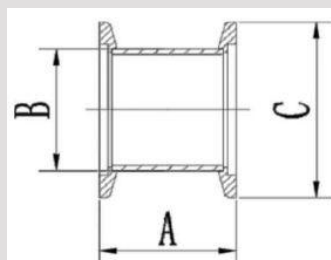
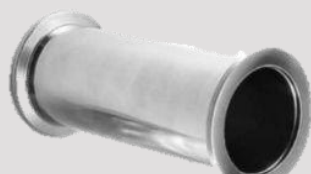

T

Material:304,316L

Finishing: Pickling, Tumbling, Sandblasting, Matt, Mirror

Remark: Other length could be customized upon request.

Model No.	Standard	A	B	C	Part No.
NW16	3A	50	19.05	30	SDA-00813
MW25	3A	50	25.4	40	SDA-00814
MW40	3A	50	38.1	55	SDA-00815
NW50	3A	50	50.8	75	SDA-00816

NW/KF 90° Mitered elbow

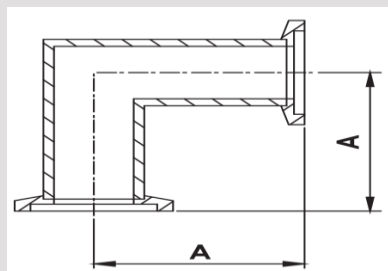

Material:304,316L

Finishing: Pickling, Tumbling, Sandblasting, Matt, Mirror

Remark: Other length could be customized upon request.

Model No.	Standard	A	Part No.
NW16	3A	29.21	SDA-00817
MW25	3A	50	SDA-00818
MW40	3A	60.96	SDA-00819
NW50	3A	69.84	SDA-00820



CONTACT

 (+972)53-938-9696

 www.sda-tech.co.il

 office@sda-tech.com

 המסגר 9, מגדל העמק, ישראל

NW/KF equal tee

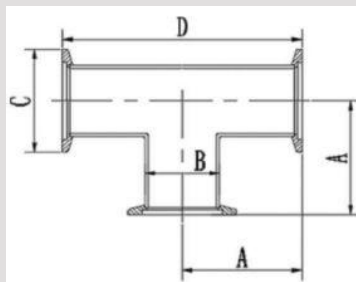

Material:304,316L

Finishing: Pickling, Tumbling, Sandblasting, Matt, Mirror

Remark: Other length could be customized upon request.

Model No.	Standard	A	B	C	D	T	Part No.
NW10	3A	31.7	12.7	30	63.5	1.5	SDA-00821
NW16	3A	40	19.05	30	80	1.65	SDA-00822
MW25	3A	50	25.4	40	100	1.65	SDA-00823
MW40	3A	65	38.1	55	130	1.65	SDA-00824
NW50	3A	70	50.8	75	140	1.65	SDA-00825
NW10	ISO	40	14	30	80	1.2	SDA-00826
NW16	ISO	32.3	19.05	30	80	1.5	SDA-00827
MW25	ISO	38.8	28	40	100	1.5	SDA-00828
MW40	ISO	51.8	42	55	130	1.5	SDA-00829
NW50	ISO	64.8	54	75	140	2	SDA-00830



CONTACT

 (+972)53-938-9696

 www.sda-tech.co.il

 office@sda-tech.com

 המסגר 9, מגדל העמק, ישראל

NW/KF Reducing tee

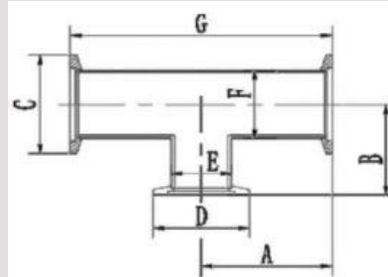

Material:304,316L

Finishing: Pickling, Tumbling, Sandblasting, Matt, Mirror

Remark: Other length could be customized upon request.

Model No.	Standard	A	B	C	D	E	F	G	Part No.
NW25x16	3A	50	40	40	30	19.05	25.4	100	SDA-00831
NW40x16	3A	65	40	55	30	19.05	38.1	130	SDA-00832
NW40x25	3A	65	50	55	40	25.4	38.1	130	SDA-00833
NW50x16	3A	70	50	75	30	19.05	50.8	140	SDA-00834
NW50x25	3A	70	65	75	40	25.4	50.8	140	SDA-00835
NW50x40	3A	70	65	75	55	38.1	50.8	140	SDA-00836

NW/KF 4-way crosses

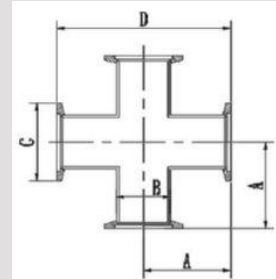

Material:304,316L

Finishing: Pickling, Tumbling, Sandblasting, Matt, Mirror

Remark: Other length could be customized upon request.

Model No.	Standard	A	B	C	D	Part No.
NW10	3A	31.75	12.7	30	63.5	SDA-00837
NW16	3A	40	19.05	30	80	SDA-00838
MW25	3A	50	25.4	40	100	SDA-00839
MW40	3A	65	38.1	55	130	SDA-00840
NW50	3A	70	50.8	75	140	SDA-00841
NW16	ISO	32.3	19.05	30	64.6	SDA-00842
MW25	ISO	38.8	25.4	40	77.6	SDA-00843
MW40	ISO	51.8	38.1	55	103.6	SDA-00844
NW50	ISO	64.8	50.8	75	129.6	SDA-00845



CONTACT

 (+972)53-938-9696

 www.sda-tech.co.il

 office@sda-tech.com

 המסגר 9, מגדל העמק, ישראל

NW/KF reducing crosses.

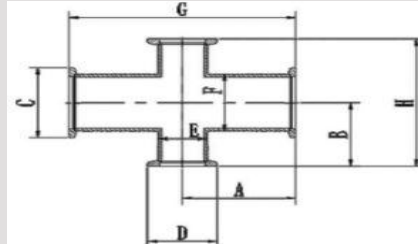

Material:304,316L

Finishing: Pickling, Tumbling, Sandblasting, Matt, Mirror

Remark: Other length could be customized upon request

Model No.	A	B	C	D	E	F	G	H	Part No.
NW-25*16	50	40	40	30	19.05	25.4	100	80	SDA-00846
NW-40*16	65	40	55	30	19.05	38.1	130	80	SDA-00847
NW-40*25	65	50	55	40	25.4	38.1	130	100	SDA-00848
NW-50*16	70	50	75	30	19.05	50.8	140	100	SDA-00849
NW-50*25	70	65	75	40	25.4	50.8	140	130	SDA-00850
NW-50*40	70	65	75	55	38.1	50.8	140	130	SDA-00851

NW/KF 5-way crosses

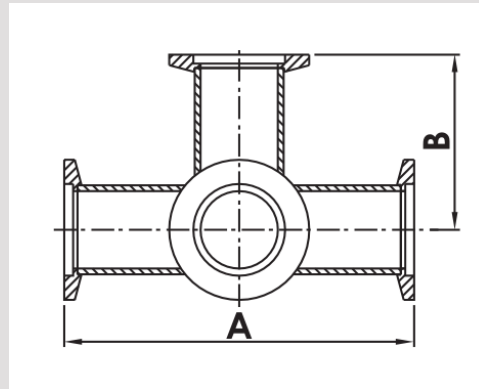

Material:304,316L

Finishing: Pickling, Tumbling, Sandblasting, Matt, Mirror

Remark: Other length could be customized upon request.

Model No.	Size	A	B	Part No.
NW16	NW16	80	40	SDA-00852
MW25	MW25	100	50	SDA-00853
MW40	MW40	130	65	SDA-00854
NW50	NW50	140	70	SDA-00855



CONTACT

 (+972)53-938-9696

 www.sda-tech.co.il

 office@sda-tech.com

 המסגר 9, מגדל העמק, ישראל

NW/KF 6-way crosses

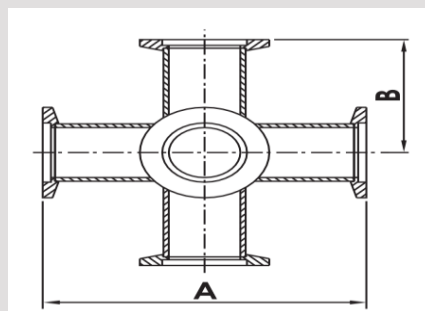

Material:304,316L

Finishing: Pickling, Tumbling, Sandblasting, Matt, Mirror

Remark: Other length could be customized upon request.

Model No.	Size	A	B	Part No.
NW16	NW16	80	40	SDA-00856
MW25	MW25	100	50	SDA-00857
MW40	MW40	130	65	SDA-00858
NW50	NW50	140	70	SDA-00859

ISO-K 90° elbow

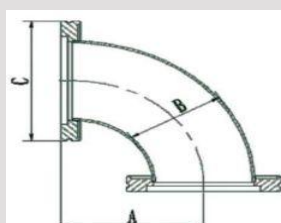

Material:304,316L

Finishing: Pickling, Tumbling, Sandblasting, Matt, Mirror

Remark: Other length could be customized upon request.

Model No.	Standard	A	B	C	Part No.
ISOK-90EL-63	3A	101.6	63.5	95	SDA-00860

עמוד 90 מתוך 183

ISOK-90EL-80	3A	120.6	76.2	110	SDA-00861
ISOK-90EL-100	3A	158.7	101.6	130	SDA-00862
ISOK-90EL-160	3A	234.9	152.4	180	SDA-00863
ISOK-90EL-63	ISO	88	63.5	95	SDA-00864
ISOK-90EL-80	ISO	98	76.2	110	SDA-00865
ISOK-90EL-100	ISO	108	101.6	130	SDA-00866
ISOK-90EL-160	ISO	138	152.4	180	SDA-00867

ISO full nipple

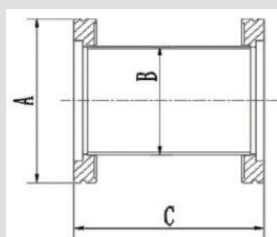
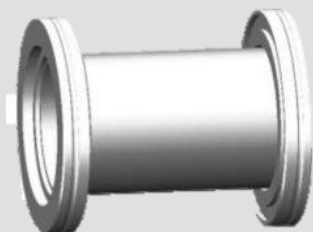

Material:304,316L

Finishing: Pickling, Tumbling, Sandblasting, Matt, Mirror

Remark: Other length could be customized upon request.

Model No.	A	B	C	Part No.
ISO-63	95	63.5	100	SDA-00868
ISO-80	110	76.2	100	SDA-00869
ISO-100	130	101.6	100	SDA-00870
ISO-160	180	152.4	100	SDA-00871
ISO-200	240	204	100	SDA-00872
ISO-250	290	254	100	SDA-00873
ISO-320	370	304.8	200	SDA-00874
ISO-400	450	406.4	200	SDA-00875
ISO-500	550	508	200	SDA-00876



CONTACT

 (+972)53-938-9696

 www.sda-tech.co.il

 office@sda-tech.com

 המסגר 9, מגדל העמק, ישראל

ISO-K Mitered elbow

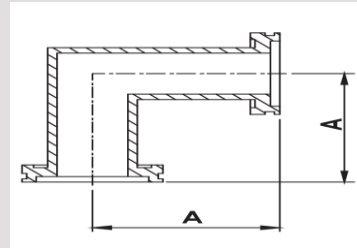

Material:304,316L

Finishing: Pickling, Tumbling, Sandblasting, Matt, Mirror

Remark: Other length could be customized upon request.

Model No.	Size	A	Part No.
ISOK-90MEL-63	ISO63	82.6	SDA-00877
ISOK-90MEL-63-1	ISO63-H	87.93	SDA-00878
ISOK-90MEL-80	ISO80	88.9	SDA-00879
ISOK-90MEL-80-1	ISO80-H	108	SDA-00880
ISOK-90MEL-100	ISO100	104.9	SDA-00881
ISOK-90MEL-100-1	ISO100-H	108	SDA-00882
ISOK-90MEL-160	ISO160	138	SDA-00883
ISOK-90MEL-160-1	ISO160-H	160.2	SDA-00884



CONTACT

 (+972)53-938-9696

 www.sda-tech.co.il

 office@sda-tech.com

 המסגר 9, מגדל העמק, ישראל

ISO-K Equal tee

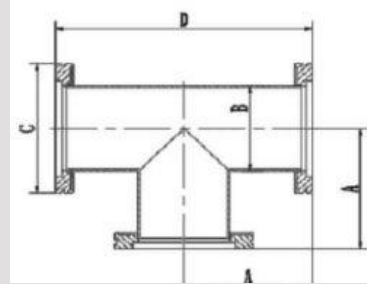

Material:304,316L

Finishing: Pickling, Tumbling, Sandblasting, Matt, Mirror

Remark: Other length could be customized upon request.

Model No.	Standard	A	B	C	D	Part No.
ISO-ET-63	3A	82.8	63.5	95	165.6	SDA-00885
ISO-ET-80	3A	89.15	76.2	110	178.3	SDA-00886
ISO-ET-100	3A	105	101.6	130	210	SDA-00887
ISO-ET-160	3A	133.6	152.4	180	267.2	SDA-00888
ISO-ET-63	ISO	88	63.5	95	176	SDA-00889
ISO-ET-80	ISO	98	76.2	110	196	SDA-00890
ISO-ET-100	ISO	108	101.6	130	216	SDA-00891
ISO-ET-160	ISO	138	152.4	180	276	SDA-00892



CONTACT

 (+972)53-938-9696

 www.sda-tech.co.il

 office@sda-tech.com

 המסגר 9, מגדל העמק, ישראל

ISO-K 4-way equal crosses

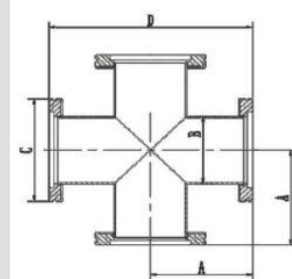
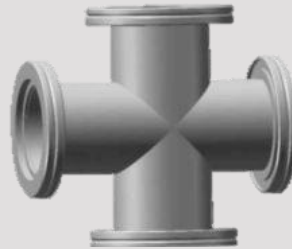

Material:304,316L

Finishing: Pickling, Tumbling, Sandblasting, Matt, Mirror

Remark: Other length could be customized upon request.

Model No.	Standard	A	B	C	D	Part No.
ISO-63	3A	82.8	63.5	95	165.6	SDA-00893
ISO-80	3A	89.15	76.2	110	178.3	SDA-00894
ISO-100	3A	105	101.6	130	210	SDA-00895
ISO-160	3A	133.6	152.4	180	267.2	SDA-00896
ISO-63	ISO	88	63.5	95	176	SDA-00897
ISO-80	ISO	98	76.2	110	196	SDA-00898
ISO-100	ISO	108	101.6	130	216	SDA-00899
ISO-160	ISO	138	152.4	180	276	SDA-00900

ISO-K 4-way reducing crosses.

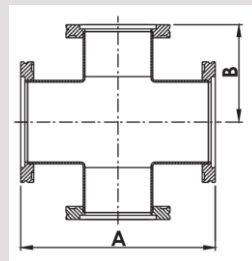

Material:304,316L

Finishing: Pickling, Tumbling, Sandblasting, Matt, Mirror

Remark: Other length could be customized upon request.

Model No.	Size	A	B	Part No.
ISOK-4RC-80x63	ISO80xISO63	177.7	88.85	SDA-00901
ISOK-4RC-100x63	ISO100xISO63	209.7	101.55	SDA-00902
ISOK-4RC-100x80	ISO100xISO80	209.7	101.55	SDA-00903
ISOK-4RC-160x63	ISO160xISO63	266.6	126.95	SDA-00904
ISOK-4RC-160x80	ISO160xISO80	266.6	126.95	SDA-00905
ISOK-4RC-160x100	ISO160xISO100	266.6	130.25	SDA-00906

ISO-K 5-way equal crosses

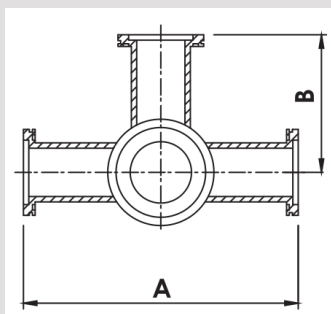

Material:304,316L

Finishing: Pickling, Tumbling,
Sandblasting, Matt, Mirror

Remark: Other length could be customized upon request.

Model No.	Size	A	B	Part No.
ISOK-5C-63	ISO63	165	82.5	SDA-00907
ISOK-5C-80	ISO80	177.8	88.9	SDA-00908
ISOK-5C-100	ISO100	209.8	104.9	SDA-00909
ISOK-5C-160	ISO160	266.6	133.3	SDA-00910

ISO-K 6-way equal crosses

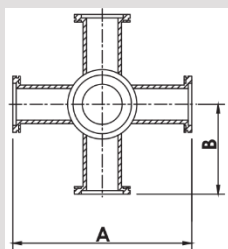

Material:304,316L

Finishing: Pickling, Tumbling, Sandblasting,
Matt, Mirror

Remark: Other length could be customized upon request.

Model No.	Size	A	B	Part No.
ISO-63	ISO63	165	82.5	SDA-00911
ISO-80	ISO80	177.8	88.9	SDA-00912
ISO-100	ISO100	209.8	104.9	SDA-00913
ISO-160	ISO160	266.6	133.3	SDA-00914



CONTACT

 (+972)53-938-9696

 www.sda-tech.co.il

 office@sda-tech.com

 המסגר 9, מגדל העמק, ישראל

CF 90° elbow

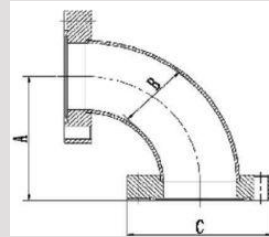

Material:304,316L

Finishing: Pickling, Tumbling, Sandblasting, Matt, Mirror Remark:

1. Other length could be customized upon request.
2. Rotatable flanges could be applied upon request.

Model No.	A	B	C	Part No.
CF-90EL-16	38.1	19.05	34	SDA-00915
CF-90EL-25	42.4	25.4	54	SDA-00916
CF-90EL-35	62.5	38.1	70	SDA-00917
CF-90EL-50	81.8	50.8	86	SDA-00918
CF-90EL-63	104.6	63.5	114	SDA-00919
CF-90EL-80	121.4	76.2	117	SDA-00920
CF-90EL-100	163.6	101.6	152	SDA-00921

CF 90° Mitered elbows

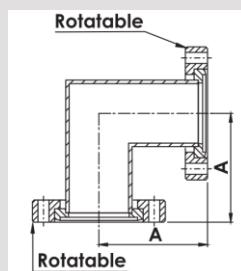

Material:304,316L

Finishing: Pickling, Tumbling, Sandblasting, Matt, Mirror Remark:

- 1.Other length could be customized upon request.
- 2.Rotatable flanges could be applied upon request.

Model No.	A	Part No.
CF-90MEL-16	38.1	SDA-00922
CF-90MEL-25	52	SDA-00923
CF-90MEL-35	62.5	SDA-00924
CF-90MEL-50	81.8	SDA-00925
CF-90MEL-63	85.9	SDA-00926
CF-90MEL-80	89.7	SDA-00927
CF-90MEL-100	109.7	SDA-00928

CF Equal tee

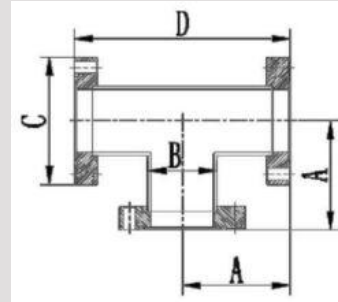

Material:304,316L Finishing: Pickling, Tumbling, Sandblasting, Matt, Mirror Remark:

- 1.Other length could be customized upon request.
- 2.Rotatable flanges could be applied upon request.

Model No.	A	B	C	D	Part No.
CF-ET-16	38.1	19.05	34	75	SDA-00929
CF-ET-25	52.05	25.4	54	104	SDA-00930
CF-ET-35	62.5	38.1	70	125	SDA-00931
CF-ET-50	81.8	50.8	86	163.6	SDA-00932
CF-ET-63	85.85	63.5	114	171.7	SDA-00933
CF-ET-80	89.7	76.2	117	179.4	SDA-00934
CF-ET-100	109.7	101.6	152	219.4	SDA-00935

CF 4-way crosses

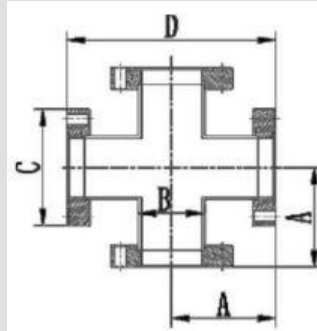

Material:304,316L

Finishing: Pickling, Tumbling,
Sandblasting, Matt, Mirror Remark:

- 1.Other length could be customized upon request.
- 2.Rotatable flanges could be applied upon request.

Model No.	A	B	C	D	Part No.
CF-4C-16	38.1	19.05	34	75	SDA-00936
CF-4C-25	52.05	25.4	54	104	SDA-00937
CF-4C-35	62.5	38.1	70	125	SDA-00938
CF-4C-50	81.8	50.8	86	163.6	SDA-00939
CF-4C-63	85.85	63.5	114	171.7	SDA-00940
CF-4C-80	89.7	76.2	117	179.4	SDA-00941
CF-4C-100	109.7	101.6	152	219.4	SDA-00942

CF 5-way crosses

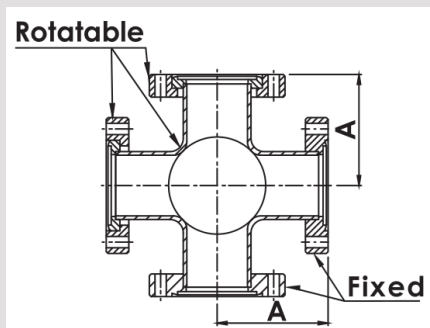

Material:304,316L

Finishing: Pickling, Tumbling, Sandblasting, Matt, Mirror

Remark:

- 1.Other length could be customized upon request.
- 2.Rotatable flanges could be applied upon request.

Model No.	A	B	C	D	Part No.
CF-5C-16	38.1	19.05	34	75	SDA-00943
CF-5C-25	52.05	25.4	54	104	SDA-00944
CF-5C-35	62.5	38.1	70	125	SDA-00945
CF-5C-50	81.8	50.8	86	163.6	SDA-00946
CF-5C-63	85.85	63.5	114	171.7	SDA-00947
CF-5C-80	92.2	76.2	117	179.4	SDA-00948
CF-5C-100	134.9	101.6	152	219.4	SDA-00949

CF 6-way crosses

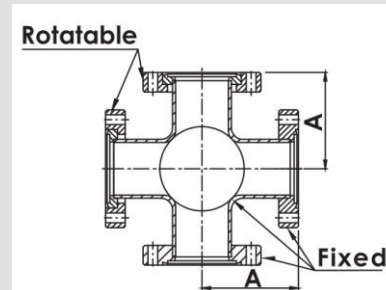

Material:304,316L

Finishing: Pickling, Tumbling, Sandblasting, Matt, Mirror

Remark:

- 1.Other length could be customized upon request.
- 2.Rotatable flanges could be applied upon request.

Model No.	A	B	C	D	Part No.
CF-6C-16	38.1	19.05	34	75	SDA-00950
CF-6C-25	52.05	25.4	54	104	SDA-00951
CF-6C-35	62.5	38.1	70	125	SDA-00952
CF-6C-50	81.8	50.8	86	163.6	SDA-00953
CF-6C-63	85.85	63.5	114	171.7	SDA-00954
CF-6C-80	92.2	76.2	117	179.4	SDA-00955
CF-6C-100	134.9	101.6	152	219.4	SDA-00956

CF 6-way cube

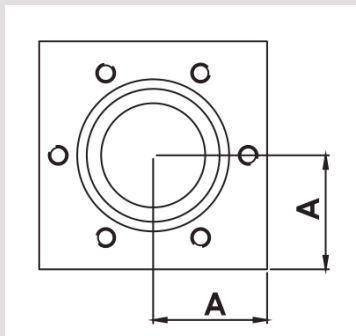

Material:304,316L

 Finishing: Pickling,
Tumbling, Sandblasting,
Matt, Mirror

Remark:

1.Other length could be customized upon request.

Model no.	A	Type	Part No.
CF-6CU-16T	17	INCH TAPPED	SDA-00957
CF-6CU-16TM	17	METRIC TAPPED	SDA-00958
CF-6CU-35T	35.05	INCH TAPPED	SDA-00959
CF-6CU-35TM	35.05	METRIC TAPPED	SDA-00960
CF-6CU-50T	42.5	INCH TAPPED	SDA-00961
CF-6CU-50TM	42.5	METRIC TAPPED	SDA-00962
CF-6CU-63T	56.75	INCH TAPPED	SDA-00963
CF-6CU-63TM	56.75	METRIC TAPPED	SDA-00964
CF-6CU-100T	75.8	INCH TAPPED	SDA-00965
CF-6CU-100TM	75.8	METRIC TAPPED	SDA-00966



CONTACT

 (+972)53-938-9696

 www.sda-tech.co.il

 office@sda-tech.com

 המסגר 9, מגדל העמק, ישראל

Centering rings





CONTACT

 (+972)53-938-9696

 www.sda-tech.co.il

 office@sda-tech.com

 המסגר 9, מגדל העמק, ישראל

General Information

Viton O-ring bakeable to 200°C intermittently, sustained use to 150°C.

Vacuum seal of KF\NW-series: O-ring compression by uniform pressure application around the 15° outer flange surface.

The vacuum seal of ISO - series is made by compressing the O-ring between the mating flanges. This done by alternately wrench-tightening opposing pairs of clamps or bolts until the first metal-to-metal contact is made between the inner surfaces of the flanges and the spacing lips of the centering ring.

Specifications:

Centering Ring :304 S.S. (Other material available upon request) ·

O-ring: Viton (Other material available upon request)

Outer Ring: Aluminum

Mesh :304 S.S.

Temperature Range :150°C (Viton) 80°C(NBR)

Larger or special size available upon request

Applications:

The O-ring is considered a universal sealing device.

Used as static, dynamic, radial or face seals.

Vacuum seal.



CONTACT

 (+972)53-938-9696

 www.sda-tech.co.il

 office@sda-tech.com

 המסגר 9, מגדל העמק, ישראל

Description:

Viton O-rings are normally used in vacuum service in place of NBR and silicone rubber.

Viton has a low porosity to most gases (except helium) and withstands high temperature (up to 200°C) for short period. NBR O-ring are low cost, but their maximum operating temperature (approx. 100 °C) makes them unacceptable for many vacuum applications.

Silicone O-rings can withstand temperatures of 250°C for short periods, but silicone tends to harden to prolonged high temperature service, sticking to the metal surfaces and making the O-ring difficult to replaced. Silicone is also very porous to helium.

טבעות O מסוג Viton לאיטום בוואקום

טבעות O מוייטון מתאימות לשימוש בטמפרטורה רציפה עד 150°C ולטווחים קצרים עד 200°C. הן משמשות בעיקר באטימה של מערכות ואקום מסדרות ISO, IKF/NW-באמצעות דחיסה אחידה של הטבעת בין אוגנים.

מבנה וחומרים

- טבעת מרכזית: נירוסטה 304 (חומרים נוספים לפי דרישה)
- טבעת Viton O: (או NBR/Silicone לפי צורך)
- טבעת חיצונית: אלומיניום
- רשת פנימית: נירוסטה 304
- טווח טמפרטורה Viton: עד 150 °C, NBR עד 80 °C

שימושים

משמשות לאטימה כללית (סטטית, דינמית, רדיאלית ופני שטח) במערכות ואקום. ויטון עדיף בזכות עמידות גבוהה בחום וחדירות נמוכה לגזים (למעט הליום). סיליקון עמיד עד 250°C אך נוטה להתקשות ולהידבק, ו NBR-זול אך מוגבל ל-100°C בלבד.

הערות נוספות

מידות גדולות או מיוחדות זמינות לפי דרישה.
דוחות חומר זמינים לפי בקשה.



CONTACT

 (+972)53-938-9696

 www.sda-tech.co.il

 office@sda-tech.com

 המסגר 9, מגדל העמק, ישראל

NWKF Center ring

Material: SS304, AL

Remark: SS304L, 316L could be supplied based on request.

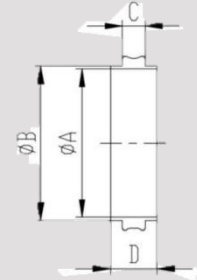

Model No.	Quality	A	B	C	D	Part No.
NW-10	304	10	12	3.9	8	SDA-00968
NW-16	304	16	17	3.9	8	SDA-00969
NW-25	304	25	26	3.9	8	SDA-00970
NW-40	304	40	41	3.9	8	SDA-00971
NW-50	304	50	52	3.9	8	SDA-00972
NW-10	AL	10	12	3.9	8	SDA-00973
NW-16	AL	16	17	3.9	8	SDA-00974
NW-25	AL	25	26	3.9	8	SDA-00975
NW-40	AL	40	41	3.9	8	SDA-00976
NW-50	AL	50	52	3.9	8	SDA-00977

NW/KF sealing O-ring

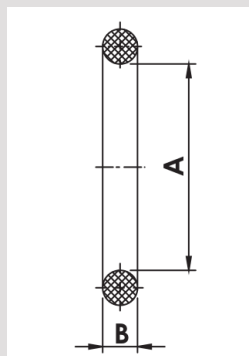

Material: Viton, NBR

Remark: Viton in brown color and NBR in black color.

Black Viton O-ring and green Viton O-ring is also available upon request.

Model No.	Quality	A	B	Part No.
NW-10	Viton	15.24	5.3	SDA-00978
NW-16	Viton	18.42	5.3	SDA-00979
NW-25	Viton	27.94	5.3	SDA-00980
NW-40	Viton	40.64	5.3	SDA-00981
NW-50	Viton	53.34	5.3	SDA-00982
NW-10	NBR	15.24	5.3	SDA-00983
NW-16	NBR	18.42	5.3	SDA-00984
NW-25	NBR	27.94	5.3	SDA-00985
NW-40	NBR	40.64	5.3	SDA-00986
NW-50	NBR	53.34	5.3	SDA-00987

NW/KF Center ring+ sealing o- ring

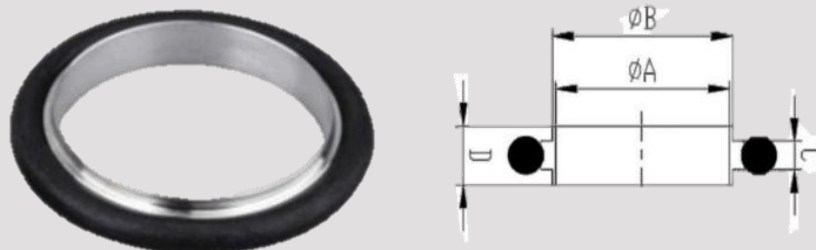

Material: SS304, AL for center ring, Viton and NBR for sealing O-ring

Remark: SS304L,316L could be supplied based on request.

Model No.	Center ring	O-Ring	A	B	C	D	Part No.
NW-10	AL	Viton	10	12	3.9	8	SDA-00988
NW-16	AL	Viton	16	17	3.9	8	SDA-00989
NW-25	AL	Viton	25	26	3.9	8	SDA-00990
NW-40	AL	Viton	40	41	3.9	8	SDA-00991
NW-50	AL	Viton	50	52	3.9	8	SDA-00992
NW-10	SS304	Viton	10	12	3.9	8	SDA-00993
NW-16	SS304	Viton	16	17	3.9	8	SDA-00994
NW-25	SS304	Viton	25	26	3.9	8	SDA-00995
NW-40	SS304	Viton	40	41	3.9	8	SDA-00996
NW-50	SS304	Viton	50	52	3.9	8	SDA-00997

NW-10	AL	NBR	10	12	3.9	8	SDA-00998
NW-16	AL	NBR	16	17	3.9	8	SDA-00999
NW-25	AL	NBR	25	26	3.9	8	SDA-01000
NW-40	AL	NBR	40	41	3.9	8	SDA-01001
NW-50	AL	NBR	50	52	3.9	8	SDA-01002
NW-10	SS304	NBR	10	12	3.9	8	SDA-01003
NW-16	SS304	NBR	16	17	3.9	8	SDA-01004
NW-25	SS304	NBR	25	26	3.9	8	SDA-01005
NW-40	SS304	NBR	40	41	3.9	8	SDA-01006
NW-50	SS304	NBR	50	52	3.9	8	SDA-01007

NW\KF Center ring+ sealing O-ring+ spacer

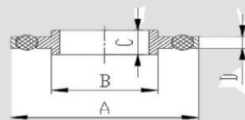

Material: SS304, AL for center ring, Viton and NBR for sealing O-ring, SS304 for out spacer.

Remark:

1. SS304L,316L for center rings could be supplied based on request.

2. 4mm out spacer is also available.

Model No.	Center ring	O-Ring	A	B	C	D	Part No.
NW-10	AL	Viton	30	12.2	3.9	8	SDA-01008
NW-16	AL	Viton	30	17.2	3.9	8	SDA-01009
NW-25	AL	Viton	41.5	26.2	3.9	8	SDA-01010



CONTACT

 (+972)53-938-9696

 www.sda-tech.co.il

 office@sda-tech.com

 המסגר 9, מגדל העמק, ישראל

NW-40	AL	Viton	56	41.2	3.9	8	SDA-01011
NW-50	AL	Viton	75	52.2	3.9	8	SDA-01012
NW-10	304	Viton	30	12.2	3.9	8	SDA-01013
NW-16	304	Viton	30	17.2	3.9	8	SDA-01014
NW-25	304	Viton	41.5	26.2	3.9	8	SDA-01015
NW-40	304	Viton	56	41.2	3.9	8	SDA-01016
NW-50	304	Viton	75	52.2	3.9	8	SDA-01017
NW-10	AL	NBR	30	12.2	3.9	8	SDA-01018
NW-16	AL	NBR	30	17.2	3.9	8	SDA-01019
NW-25	AL	NBR	41.5	26.2	3.9	8	SDA-01020
NW-40	AL	NBR	56	41.2	3.9	8	SDA-01021
NW-50	AL	NBR	75	52.2	3.9	8	SDA-01022
NW-10	304	NBR	30	12.2	3.9	8	SDA-01023
NW-16	304	NBR	30	17.2	3.9	8	SDA-01024
NW-25	304	NBR	41.5	26.2	3.9	8	SDA-01025
NW-40	304	NBR	56	41.2	3.9	8	SDA-01026
NW-50	304	NBR	75	52.2	3.9	8	SDA-01027



CONTACT

 (+972)53-938-9696

 www.sda-tech.co.il

 office@sda-tech.com

 המסגר 9, מגדל העמק, ישראל

NW\KF Trapped center ring

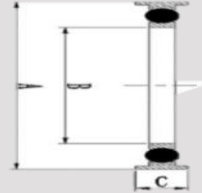
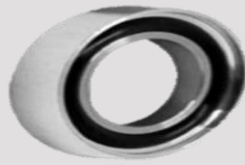

Material: SS304, AL for center ring, Viton and NBR for sealing O-ring, Aluminum for out spacer. Remark:

1. SS304L,316L for center rings could be supplied based on request.

2.7mm out spacer is also available.

Model No.	Out ring	Center ring	O-Ring	A	B	C	Part No.
NW-CROS-16	AL	304	Viton	30	17.2	8	SDA-01028
NW-CROS-25	AL	304	Viton	41.5	26.2	8	SDA-01029
NW-CROS-40	AL	304	Viton	56	41.2	8	SDA-01030
NW-CROS-50	AL	304	Viton	75	52.2	8	SDA-01031

NWKF Screened center ring+ sealing O-ring.

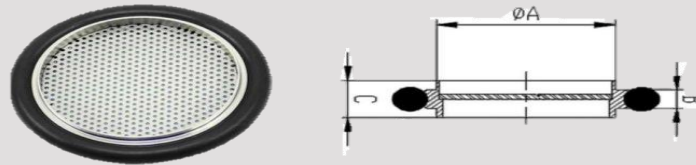

Material: SS304 for center ring, Viton and NBR for sealing O-ring Remark:

1. SS304L,316L for center rings could be supplied based on request.

2. There are three kinds of mesh size for KF screened center rings.

Model No.	Center ring	O-Ring	A	B	C	Part No.
NW-10	304	Viton	12	3.9	8	SDA-01032
NW-16	304	Viton	17	3.9	8	SDA-01033
NW-25	304	Viton	26	3.9	8	SDA-01034
NW-40	304	Viton	41	3.9	8	SDA-01035
NW-50	304	Viton	52	3.9	8	SDA-01036
NW-10	304	NBR	12	3.9	8	SDA-01037
NW-16	304	NBR	17	3.9	8	SDA-01038
NW-25	304	NBR	26	3.9	8	SDA-01039
NW-40	304	NBR	41	3.9	8	SDA-01040
NW-50	304	NBR	52	3.9	8	SDA-01041

ISO Center ring (EU standard)

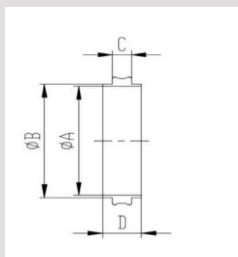

Material: SS304, AL

Remark:

1. SS304L,316L could be supplied based on request.
2. This center ring is with a notch.

Model No.	Center ring	A	B	C	D	Part No.
ISO-63	AL	67	70	3.9	8	SDA-01042
ISO-80	AL	80	83	3.9	8	SDA-01043
ISO-100	AL	99	102	3.9	8	SDA-01044
ISO-160	AL	150	153	3.9	8	SDA-01045
ISO-200	AL	210	213	3.9	8	SDA-01046
ISO-250	AL	257.5	261	3.9	8	SDA-01047
ISO-320	AL	312	318	5.6	12	SDA-01048
ISO-400	AL	394	400	5.6	12	SDA-01049
ISO-500	AL	494	501	5.6	12	SDA-01050
ISO-63	304	67	70	3.9	8	SDA-01051
ISO-80	304	80	83	3.9	8	SDA-01052
ISO-100	304	99	102	3.9	8	SDA-01053
ISO-160	304	150	153	3.9	8	SDA-01054
ISO-200	304	210	213	3.9	8	SDA-01055
ISO-250	304	257.5	261	3.9	8	SDA-01056
ISO-320	304	312	318	5.6	12	SDA-01057
ISO-400	304	394	400	5.6	12	SDA-01058
ISO-500	304	494	501	5.6	12	SDA-01059

ISO Center ring (US standard)

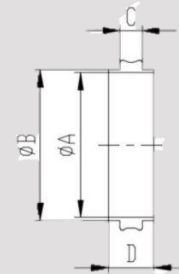

Material: SS304, AL

Remark:

1. SS304L,316L could be supplied based on request.

2.This center ring is without a notch.

Model No.	Center ring	A	B	C	D	Part No.
ISO-63	AL	67	69.6	3.9	8	SDA-01060
ISO-80	AL	80	82.6	3.9	8	SDA-01061
ISO-100	AL	99	101.6	3.9	8	SDA-01062
ISO-160	AL	150	152.6	3.9	8	SDA-01063
ISO-200	AL	210	212.6	3.9	8	SDA-01064
ISO-250	AL	257.5	260.6	3.9	8	SDA-01065
ISO-320	AL	312	317.3	5.6	12	SDA-01066
ISO-400	AL	394	399.2	5.6	12	SDA-01067
ISO-500	AL	494	500.2	5.6	12	SDA-01068
ISO-63	304	67	69.6	3.9	8	SDA-01069

ISO-80	304	80	82.6	3.9	8	SDA-01070
ISO-100	304	99	101.6	3.9	8	SDA-01071
ISO-160	304	150	152.6	3.9	8	SDA-01072
ISO-200	304	210	212.6	3.9	8	SDA-01073
ISO-250	304	257.5	260.6	3.9	8	SDA-01074
ISO-320	304	312	317.3	5.6	12	SDA-01075
ISO-400	304	394	399.2	5.6	12	SDA-01076
ISO-500	304	494	500.2	5.6	12	SDA-01077

ISO Center ring+ sealing ring(EU standard)

O-ring



Material: SS304, AL for center ring, Viton for sealing

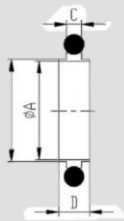

Remark:

1. SS304L,316L center ring could be supplied based on request.

2.This center ring is with a notch.

Model No.	Center ring	O-Ring	A	B	C	D	Part No.
ISO-63	AL	Viton	67	70	3.9	8	SDA-01078
ISO-80	AL	Viton	80	83	3.9	8	SDA-01079
ISO-100	AL	Viton	99	102	3.9	8	SDA-01080
ISO-160	AL	Viton	150	153	3.9	8	SDA-01081
ISO-200	AL	Viton	210	213	3.9	8	SDA-01082
ISO-250	AL	Viton	257.5	261	3.9	8	SDA-01083
ISO-320	AL	Viton	312	318	5.6	12	SDA-01084
ISO-400	AL	Viton	394	400	5.6	12	SDA-01085



CONTACT

 (+972)53-938-9696

 www.sda-tech.co.il

 office@sda-tech.com

 המסגר 9, מגדל העמק, ישראל

ISO-500	AL	Viton	494	501	5.6	12	SDA-01086
ISO-63	SS304	Viton	67	70	3.9	8	SDA-01087
ISO-80	SS304	Viton	80	83	3.9	8	SDA-01088
ISO-100	SS304	Viton	99	102	3.9	8	SDA-01089
ISO-160	SS304	Viton	150	153	3.9	8	SDA-01090
ISO-200	SS304	Viton	210	213	3.9	8	SDA-01091
ISO-250	SS304	Viton	257.5	261	3.9	8	SDA-01092
ISO-320	SS304	Viton	312	318	5.6	12	SDA-01093
ISO-400	SS304	Viton	394	400	5.6	12	SDA-01094
ISO-500	SS304	Viton	494	501	5.6	12	SDA-01095

ISO Center ring sealing o- ring(US standard)

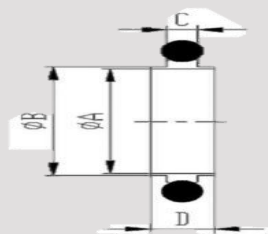

Material: SS304, AL for center ring, Viton for sealing O-ring

Remark:

1. SS304L,316L center ring could be supplied based on request.

2.This center ring is without a notch.

Model No.	Center ring	O-Ring	A	B	C	D	Part No.
ISO-63	AL	Viton	67	69.6	3.9	8	SDA-01096



CONTACT

 (+972)53-938-9696

 www.sda-tech.co.il

 office@sda-tech.com

 המסגר 9, מגדל העמק, ישראל

ISO-80	AL	Viton	80	82.6	3.9	8	SDA-01097
ISO-100	AL	Viton	99	101.6	3.9	8	SDA-01098
ISO-160	AL	Viton	150	152.6	3.9	8	SDA-01099
ISO-200	AL	Viton	210	212.6	3.9	8	SDA-01100
ISO-250	AL	Viton	257.5	260.6	3.9	8	SDA-01101
ISO-320	AL	Viton	312	317.3	5.6	12	SDA-01102
ISO-400	AL	Viton	394	399.2	5.6	12	SDA-01103
ISO-500	AL	Viton	494	500.2	5.6	12	SDA-01104
ISO-63	304	Viton	67	69.6	3.9	8	SDA-01105
ISO-80	304	Viton	80	82.6	3.9	8	SDA-01096
ISO-100	304	Viton	99	101.6	3.9	8	SDA-01097
ISO-160	304	Viton	150	152.6	3.9	8	SDA-01098
ISO-200	304	Viton	210	212.6	3.9	8	SDA-01099
ISO-250	304	Viton	257.5	260.6	3.9	8	SDA-01100
ISO-320	304	Viton	312	317.3	5.6	12	SDA-01101
ISO-400	304	Viton	394	399.2	5.6	12	SDA-01102
ISO-500	304	Viton	494	500.2	5.6	12	SDA-01103

ISO center ring+ seal O-ring+ spacer (EU standard)

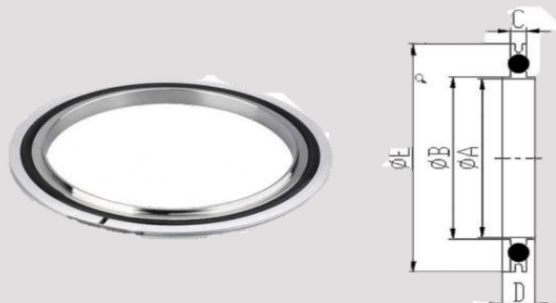

Material: SS304, AL for center ring, Viton for sealing O-ring, AL for outer spacer

Remark:

1. SS304L,316L center ring could be supplied based on request.
2. This center ring is with a notch. SS spacer is available upon request.

Model No.	Center ring	O-Ring	A	B	C	D	E	Part No.
ISO-63	AL	Viton	67	70	3.9	8	94	SDA-01104
ISO-80	AL	Viton	80	83	3.9	8	109	SDA-01105
ISO-100	AL	Viton	99	102	3.9	8	128	SDA-01106
ISO-160	AL	Viton	150	153	3.9	8	179	SDA-01107
ISO-200	AL	Viton	210	213	3.9	8	238	SDA-01108
ISO-250	AL	Viton	257.5	261	3.9	8	287	SDA-01109
ISO-320	AL	Viton	312	318	5.6	12	344	SDA-01110
ISO-400	AL	Viton	394	400	5.6	12	446	SDA-01111



CONTACT

 (+972)53-938-9696

 www.sda-tech.co.il

 office@sda-tech.com

 המסגר 9, מגדל העמק, ישראל

ISO-500	AL	Viton	494	501	5.6	12	535	SDA-01112
ISO-63	304	Viton	67	70	3.9	8	94	SDA-01113
ISO-80	304	Viton	80	83	3.9	8	109	SDA-01114
ISO-100	304	Viton	99	102	3.9	8	128	SDA-01115
ISO-160	304	Viton	150	153	3.9	8	179	SDA-01116
ISO-200	304	Viton	210	213	3.9	8	238	SDA-01117
ISO-250	304	Viton	257.5	261	3.9	8	287	SDA-01118
ISO-320	304	Viton	312	318	5.6	12	344	SDA-01119
ISO-400	304	Viton	394	400	5.6	12	446	SDA-01120
ISO-500	304	Viton	494	501	5.6	12	535	SDA-01121

ISO center ring + seal O-ring+ spacer (US standard)

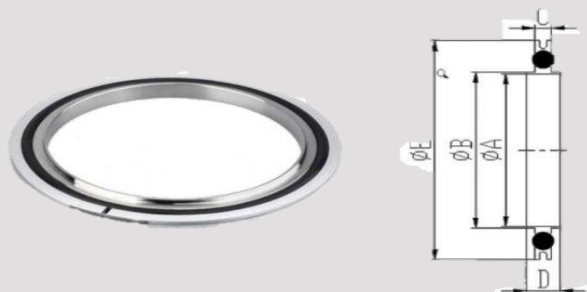

Material: SS304, AL for center ring, Viton for sealing O-ring, AL for outer spacer

Remark:

1. SS304L,316L center ring could be supplied based on request.
- 2.This center ring is without a notch.
- 3.SS spacer is available upon request.

Model No.	Center ring	O-Ring	A	B	C	D	E	Part No.
ISO-63	AL	Viton	67	69.6	3.9	8	94	SDA-01122
ISO-80	AL	Viton	80	82.6	3.9	8	109	SDA-01123
ISO-100	AL	Viton	99	101.6	3.9	8	128	SDA-01124
ISO-160	AL	Viton	150	152.6	3.9	8	179	SDA-01125
ISO-200	AL	Viton	210	212.6	3.9	8	238	SDA-01126
ISO-250	AL	Viton	257.5	260.6	3.9	8	287	SDA-01127
ISO-320	AL	Viton	312	317.3	5.6	12	344	SDA-01128
ISO-400	AL	Viton	394	399.2	5.6	12	446	SDA-01129



CONTACT

 (+972)53-938-9696

 www.sda-tech.co.il

 office@sda-tech.com

 המסגר 9, מגדל העמק, ישראל

ISO-500	AL	Viton	494	500.2	5.6	12	535	SDA-01130
ISO-63	304	Viton	67	69.6	3.9	8	94	SDA-01131
ISO-80	304	Viton	80	82.6	3.9	8	109	SDA-01132
ISO-100	304	Viton	99	101.6	3.9	8	128	SDA-01133
ISO-160	304	Viton	150	152.6	3.9	8	179	SDA-01134
ISO-200	304	Viton	210	212.6	3.9	8	238	SDA-01135
ISO-250	304	Viton	257.5	260.6	3.9	8	287	SDA-01136
ISO-320	304	Viton	312	317.3	5.6	12	344	SDA-01137
ISO-400	304	Viton	394	399.2	5.6	12	446	SDA-01138
ISO-500	304	Viton	494	500.2	5.6	12	535	SDA-01139

ISO screened center ring sealing o- ring + spacer.

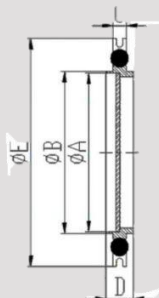

Material: SS304 for center ring, Viton for sealing O-ring, AL for outer spacer

Remark:

1. This center ring is without a notch.
2. SS spacer is available upon request.

Model No.	CR	O-Ring	A	B	C	D	E	Part No.
ISO-63	304	Viton	67	69.6	3.9	8	94	SDA-01140
ISO-80	304	Viton	80	82.6	3.9	8	109	SDA-01141
ISO-100	304	Viton	99	101.6	3.9	8	128	SDA-01142
ISO-160	304	Viton	150	152.6	3.9	8	179	SDA-01143
ISO-200	304	Viton	210	212.6	3.9	8	238	SDA-01144
ISO-250	304	Viton	257.5	260.6	3.9	8	287	SDA-01145
ISO-320	304	Viton	312	317.3	5.6	12	344	SDA-01146
ISO-400	304	Viton	394	399.2	5.6	12	446	SDA-01147
ISO-500	304	Viton	494	500.2	5.6	12	535	SDA-01148



CONTACT

 (+972)53-938-9696

 www.sda-tech.co.il

 office@sda-tech.com

 המסגר 9, מגדל העמק, ישראל

ISO O-ring

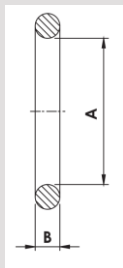

Material: Viton

Remark: Viton in brown color. Black Viton O-ring and green Viton O-ring is also available upon request.

Model No.	A	B	Part No.
ISO-63	72.39	5.33	SDA-01149
ISO-80	85.09	5.33	SDA-01150
ISO-100	104.14	5.33	SDA-01151
ISO-160	151.77	5.33	SDA-01152
ISO-200	215.27	5.33	SDA-01153
ISO-250	266.07	5.33	SDA-01154
ISO-320	316.87	6.99	SDA-01155
ISO-400	393.07	6.99	SDA-01156



CONTACT

 (+972)53-938-9696

 www.sda-tech.co.il

 office@sda-tech.com

 המסגר 9, מגדל העמק, ישראל

ISO Spacer ring



Material: Aluminum

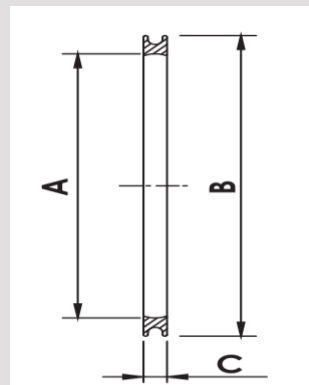

Model No.	A	B	C	Part No.
ISO-63	88.8	98	3.75	SDA-01157
ISO-80	101.8	111	3.75	SDA-01158
ISO-100	120.8	130	3.75	SDA-01159
ISO-160	170.1	179.3	3.75	SDA-01160
ISO-200	232.1	241.3	3.75	SDA-01161
ISO-250	282.1	291.3	3.75	SDA-01162
ISO-320	335.5	344	5.59	SDA-01163
ISO-400	420.3	428.8	5.59	SDA-01164

Vacuum adaptors





CONTACT

 (+972)53-938-9696

 office@sda-tech.com

 www.sda-tech.co.il

 המסגר 9, מגדל העמק, ישראל

General Information

Feature:

Adaptor flanges mate one type of flange system to another. They are available for all major systems, such as Conflate-compatible (CF), KF, ISO and ANSI.

Unless stated otherwise, all adaptors are stainless steel.

Most flange systems have been adapted to the ANSI flanges. This catalog lists only the most popular, but we can provide almost unlimited variations and modifications to suit individual requirements.

Specifications:

Flange :304 S.S. (Other material available upon request)

Tube or Pipe :304 S.S. (Other material available upon request)

Adaptor :304 S.S. (Other material available upon request)

Larger or special size available upon request

Applications:

Connection exchange.

Piping size variations and modifications to suit individual requirement.

KF female pipe adaptors are used to insert a PT (NPT) threaded pressure gauge or up-to-air valve into a fore line. Often a KF tee is inserted into the fore line joint, and the third port closed with an adaptor.

KF male pipe adaptors are flanged stubs that terminate in threads ranging from 1/8" to 1". Use Teflon tope for sealing threaded joint.

KF rubber hose adaptors are made from stainless steel with a flange at one end and a rubber tubing adaptor at the other. The tubing adaptor is compatible with standard hose bores.

עמוד 127 מתוך 183



CONTACT

 (+972)53-938-9696

 www.sda-tech.co.il

 office@sda-tech.com

 המסגר 9, מגדל העמק, ישראל

KF quick-disconnect adaptor mates a KF flange with an O-ring quick coupling. The quick couplings make a vacuum joint with any smooth-surfaced standard O.D. tube. Their most common application is attaching tubulated ion or thermocouple gauges to a system.

Swagelok® fittings provide a torque-free seal at all tubing connections and eliminate hazardous leaks in instrumentation and process tubing.

VCR® adaptors are used to connect a male or female VCR component to an existing flange system. VCR's seal by the compression of a gasket (usually copper) between two highly polished beads on the surfaces of the VCR connectors.

מתאמי אוגנים - Adaptor Flanges

מתאמי אוגנים מחברים בין מערכות אוגנים שונות (CF, KF, ISO, ANSI), כולם מנירוסטה 304 אלא אם צוין אחרת. ניתן לספק גרסאות מיוחדות לפי דרישה.

מפרט טכני

- אוגנים, צינורות ומתאמים: נירוסטה 304 (חומרים נוספים זמינים)
- זמינות למידות מיוחדות או גדולות

שימושים עיקריים

- חיבור בין מערכות שונות
- שינוי קוטר צנרת לפי דרישות ספציפיות
- התאמות למדי לחץ, שסתומים, או מדידות ואקום
- מתאמים מהירים מסוג KF לאטימה עם O-Ring
- מתאמי צינור גומי - חיבור בין אוגן לצינור גמיש
- מתאמי Swagelok® לאטימה נטולת מומנט בצנרת
- מתאמי VCR® לאטימה מדויקת באמצעות גש פריך (לרוב נחושת)



CONTACT

 (+972)53-938-9696

 www.sda-tech.co.il

 office@sda-tech.com

 המסגר 9, מגדל העמק, ישראל

ISO-K/KF straight adaptor

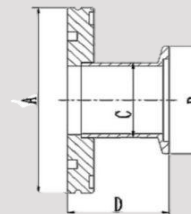

Material: SS304

Remark: SS316L is available upon request.

Model No.	A	B	C	D	Part No.
AD-ISOKF-63*16	95	30	19.05	52	SDA-01165
AD-ISOKF-63*25	95	40	25.4	52	SDA-01166
AD-ISOKF-63*40	95	55	38.1	52	SDA-01167
AD-ISOKF-63*50	95	75	50.8	52	SDA-01168
AD-ISOKF-80*16	110	30	19.05	52	SDA-01169
AD-ISOKF-80*25	110	40	25.4	52	SDA-01170
AD-ISOKF-80*40	110	55	38.1	52	SDA-01171
AD-ISOKF-80*50	110	75	50.8	52	SDA-01172
AD-ISOKF-100*16	130	30	19.05	52	SDA-01173
AD-ISOKF-100*25	130	40	25.4	52	SDA-01174
AD-ISOKF-100*40	130	55	38.1	52	SDA-01175
AD-ISOKF-100*50	130	75	50.8	52	SDA-01176
AD-ISOKF-160*16	180	30	19.05	52	SDA-01177
AD-ISOKF-160*25	180	40	25.4	52	SDA-01178
AD-ISOKF-160*40	180	55	38.1	52	SDA-01179
AD-ISOKF-160*50	180	75	50.8	52	SDA-01180



CONTACT

 (+972)53-938-9696

 www.sda-tech.co.il

 office@sda-tech.com

 המסגר 9, מגדל העמק, ישראל

KF/CF straight adaptor

Material: SS304

Remark: SS316L is available upon request.

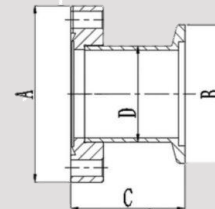

Model No.	A	B	C	D	Part No.
AD-CFKF-16*10	34	30	43	12.7	SDA-01181
AD-CFKF-16*16	34	30	43	19.09	SDA-01182
AD-CFKF-25*10	54	30	45	12.7	SDA-01183
AD-CFKF-25*16	54	30	45	19.09	SDA-01184
AD-CFKF-25*25	54	40	45	25.4	SDA-01185
AD-CFKF-35*10	70	30	45.5	12.7	SDA-01186
AD-CFKF-35*16	70	30	45.5	19.05	SDA-01187
AD-CFKF-35*25	70	40	45.5	25.4	SDA-01188
AD-CFKF-35*40	70	55	45.5	38.1	SDA-01189

AD-CFKF-50*16	86	30	48	19.05	SDA-01190
AD-CFKF-50*25	86	40	48	25.4	SDA-01191
AD-CFKF-50*40	86	55	48	38.1	SDA-01192
AD-CFKF-50*50	86	75	48	50.8	SDA-01193

ISO-K/CF Straight adaptor

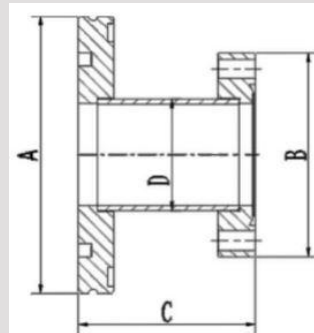

Material: SS304

Remark: SS316L is available upon request.

Model No.	A	B	C	D	Part No.
AD-ISOCF-63*16	95	34	90	19.05	SDA-01194
AD-ISOCF-63*35	95	70	90	38.1	SDA-01195
AD-ISOCF-63*50	95	86	90	50.8	SDA-01196
AD-ISOCF-63*63	95	114	90	63.5	SDA-01197
AD-ISOCF-80*16	110	34	90	19.05	SDA-01198
AD-ISOCF-80*35	110	70	90	38.1	SDA-01199
AD-ISOCF-80*50	110	86	90	50.8	SDA-01200
AD-ISOCF-100*16	130	34	90	19.05	SDA-01201



CONTACT

 (+972)53-938-9696

 www.sda-tech.co.il

 office@sda-tech.com

 המסגר 9, מגדל העמק, ישראל

AD-ISOCF-100*35	130	70	90	38.1	SDA-01202
AD-ISOCF-100*50	130	86	90	50.8	SDA-01203
AD-ISOCF-160*63	180	114	90	63.5	SDA-01204
AD-ISOCF-160*100	180	152	90	101.6	SDA-01205
AD-ISOCF-160*150	180	202	90	152.4	SDA-01206
AD-ISOCF-100*63	152	95	90	63.5	SDA-01207
AD-ISOCF-100*80	152	110	90	76.2	SDA-01208
AD-ISOCF-100*100	152	130	90	101.6	SDA-01209
AD-ISOCF-63*150	202	95	90	63.5	SDA-01210
AD-ISOCF-100*150	202	130	90	101.6	SDA-01211

CF Reducer, fixed.

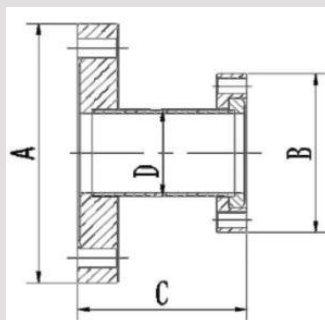

Material: SS304

Remark: SS316L is available upon request.

Model No.	A	B	C	D	Part No.
CF-RA-35*16	70	34	76	19.05	SDA-01212
CF-RA-35*25	70	54	76	25.4	SDA-01213
CF-RA-63*16	114	34	76	19.05	SDA-01214
CF-RA-63*25	114	54	76	25.4	SDA-01215

עמוד 132 מתוך 183



CONTACT

 (+972)53-938-9696

 www.sda-tech.co.il

 office@sda-tech.com

 המסגר 9, מגדל העמק, ישראל

Model No.	A	B	C	D	Part No.
CF-RA-63*35	114	70	76	38.1	SDA-01216
CF-RA-100*35	152	70	76	38.1	SDA-01217
CF-RA-100*63	152	114	76	63.5	SDA-01218
CF-RA-150*35	202	70	76	38.1	SDA-01219
CF-RA-150*63	202	114	76	63.5	SDA-01220
CF-RA-150*100	202	152	76	101.6	SDA-01221

CF reducer, rotatable

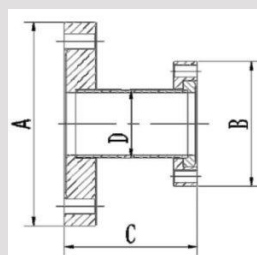

Material: SS304

Remark: SS316L is available upon request.

Model No.	A	B	C	D	Part No.
CF-RA-35*16R	70	34	76	19.05	SDA-01222
CF-RA-35*25R	70	54	76	25.4	SDA-01223
CF-RA-63*16R	114	34	76	19.05	SDA-01224
CF-RA-63*25R	114	54	76	25.4	SDA-01225
CF-RA-63*35R	114	70	76	38.1	SDA-01226
CF-RA-100*35R	152	70	76	38.1	SDA-01227
CF-RA-100*63R	152	114	76	63.5	SDA-01228
CF-RA-150*35R	202	70	76	38.1	SDA-01229
CF-RA-150*63R	202	114	76	63.5	SDA-01230
CF-RA-150*100R	202	152	76	101.6	SDA-01231



CONTACT

 (+972)53-938-9696

 www.sda-tech.co.il

 office@sda-tech.com

 המסגר 9, מגדל העמק, ישראל

NWKF conical reducer

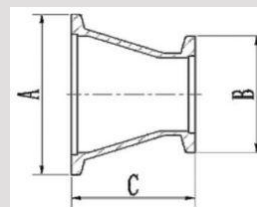

Material: SS304

Remark: SS316L is available upon request.

Model No.	A	B	C	Part No.
NW25*16	40	30	40	SDA-01232
NW40*16	55	30	40	SDA-01233
NW40*25	55	40	40	SDA-01234
NW50*16	75	30	40	SDA-01235
NW50*25	75	40	40	SDA-01236
NW50*40	75	55	40	SDA-01237

ISO straight reducer

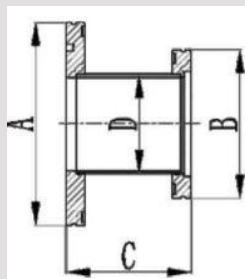

Material: SS304

Remark: SS316L is available upon request.

Model No.	A	B	C	D	Part No.
ISO-80*63	110	95	63	63.5	SDA-01238

ISO-100*63	130	96	63	63.5	SDA-01239
ISO-100*80	130	110	63	76.2	SDA-01240
ISO-160*63	180	95	63	63.5	SDA-01241
ISO-160*80	180	110	63	76.2	SDA-01242
ISO-160*100	180	130	63	101.6	SDA-01243

KF-VCR male adaptor

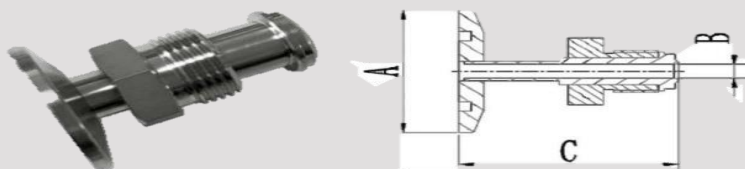

Material: SS304 for KF flange and SS316L for VCR

Remark: Length and other special sizes could be customized based on request.

Model No.	A	B	C	VCR	Part No.
AD-KFVCRM-16*025	30	4.4	37	1/4	SDA-01243
AD-KFVCRM-16*050	30	10.4	41.9	1/2	SDA-01244
AD-KFVCRM-25*025	40	4.4	37	1/4	SDA-01245
AD-KFVCRM-25*050	40	10.4	41.9	1/2	SDA-01246
AD-KFVCRM-40*025	55	4.4	37	1/4	SDA-01247
AD-KFVCRM-40*050	55	10.4	41.9	1/2	SDA-01248
AD-KFVCRM-50*025	75	4.4	37	1/4	SDA-01249
AD-KFVCRM-50*050	75	10.4	41.9	1/2	SDA-01250

KF-VCR Female adaptor

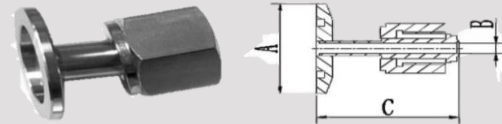

Material: SS304 for KF flange and SS316L for VCR

Remark: Length and other special sizes could be customized based on request.

Model no.	A	B	C	VCR	Part no.
AD-KFVCRF16*025	30	4.4	44	1/4	SDA-01251
AD-KFVCRF16*050	30	10.4	46	1/2	SDA-01252
AD-KFVCRF25*025	40	4.4	44	1/4	SDA-01253
AD-KFVCRF25*050	40	10.4	46	1/2	SDA-01254
AD-KFVCRF40*025	55	4.4	44	1/4	SDA-01255
AD-KFVCRF40*050	55	10.4	46	1/2	SDA-01256
AD-KFVCRF50*025	75	4.4	44	1/4	SDA-01257
AD-KFVCRF50*050	75	10.4	46	1/2	SDA-01258



CONTACT

 (+972)53-938-9696

 www.sda-tech.co.il

 office@sda-tech.com

 המסגר 9, מגדל העמק, ישראל

KF-Swagelok adaptor



Material: SS304 for KF flange and SS316L for Swagelok

Remark: Length and other special sizes could be customized based on request.

Model No.	A	B	C	Swagelok	Part no.
AD-KFSWG-16*025	30	5	36.6	1/4	SDA-01259
AD-KFSWG-16*050	30	11	45	1/2	SDA-01260
AD-KFSWG-25*025	40	5	36.6	1/4	SDA-01261
AD-KFSWG-25*050	40	11	54.3	1/2	SDA-01262
AD-KFSWG-40*025	55	5	36.6	1/4	SDA-01263
AD-KFSWG-40*050	55	11	54.3	1/2	SDA-01264
AD-KFSWG-50*025	75	5	36.6	1/4	SDA-01265
AD-KFSWG-50*050	75	11	54.3	1/2	SDA-01266

ISO to KF Flange conical adaptors.

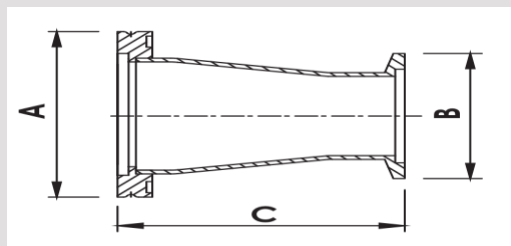

Material: SS304

Remark: SS316L is available upon request.

Model No.	A	B	C	Part No.
AD-C-ISOKF-63x40	ISO63	KF 40	70.4	SDA-01347
AD-C-ISOKF-63x50	ISO63	KF 50	70.4	SDA-01348
AD-C-ISOKF-80x40	ISO80	KF 40	102.2	SDA-01349
AD-C-ISOKF-80x50	ISO80	KF 50	102.2	SDA-01350
AD-C-ISOKF-100x50	ISO100	KF 50	102.2	SDA-01351

KF flange to hose nozzles

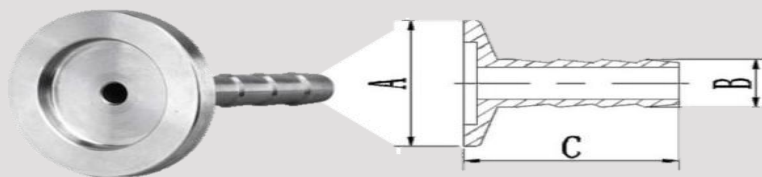

Material: SS304 Remark: SS316L is available upon request.

Model No.	A	B	C	Nozzle OD	Part No.
AD-HS-KF10x008M	30	8	40	8	SDA-01267
AD-HS-KF10x010M	30	10	40	10	SDA-01268
AD-HS-KF16x006M	30	6	40	6	SDA-01269
AD-HS-KF16x008M	30	8	40	8	SDA-01270
AD-HS-KF16x010M	30	10	40	10	SDA-01271
AD-HS-KF16x013M	30	13	40	13	SDA-01272
AD-HS-KF16x016M	30	16	40	16	SDA-01273
AD-HS-KF16x020M	30	20	40	20	SDA-01274
AD-HS-KF25x006M	40	6	40	6	SDA-01275
AD-HS-KF25x008M	40	8	40	8	SDA-01276
AD-HS-KF25x010M	40	10	40	10	SDA-01277
AD-HS-KF25x013M	40	13	40	13	SDA-01278
AD-HS-KF25x016M	40	16	40	16	SDA-01279
AD-HS-KF25x020M	40	20	40	20	SDA-01280
AD-HS-KF25x025M	40	25	40	25	SDA-01281



CONTACT

 (+972)53-938-9696

 www.sda-tech.co.il

 office@sda-tech.com

 המסגר 9, מגדל העמק, ישראל

AD-HS-KF40x016M	55	16	40	16	SDA-01282
AD-HS-KF40x020M	55	20	40	20	SDA-01283
AD-HS-KF40x025M	55	25	40	25	SDA-01284
AD-HS-KF40x032M	55	32	40	32	SDA-01285
AD-HS-KF40x040M	55	40	40	40	SDA-01286
AD-HS-KF50x025M	75	25	40	25	SDA-01287
AD-HS-KF50x050M	75	50	40	50	SDA-01288

NW\KF flange to male pipe adaptors

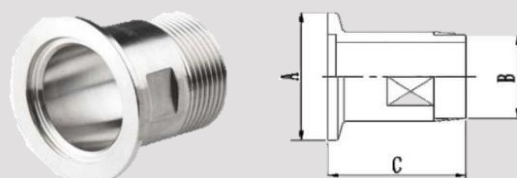

Material: SS304

Remark: SS316L is available upon request.

NPT thread is available upon request.

Model No.	A	B	C	Thread size	Part No.
AD-KFBSPT-16*0125	30	9.5	40	1/8"PT	SDA-01289
AD-KFBSPT-16*025	30	12.5	40	1/4"PT	SDA-01290
AD-KFBSPT-16*0375	30	16	40	3/8"PT	SDA-01291
AD-KFBSPT-16*050	30	20	40	1/2"PT	SDA-01292
AD-KFBSPT-25*025	40	12.5	40	1/4"PT	SDA-01293

עמוד 140 מתוך 183



CONTACT

 (+972)53-938-9696

 www.sda-tech.co.il

 office@sda-tech.com

 המסגר 9, מגדל העמק, ישראל

AD-KFBSPT-25*025375	40	16	40	3/8*PT	SDA-01294
AD-KFBSPT-25*050	40	20	40	1/2"PT	SDA-01295
AD-KFBSPT-25*075	40	25.5	40	3/4*PT	SDA-01296
AD-KFBSPT-25*100	40	32	40	1*PT	SDA-01297
AD-KFBSPT-40*050	55	20	40	1/2"PT	SDA-01298
AD-KFBSPT-40*075	55	25.5	40	3/4"PT	SDA-01299
AD-KFBSPT-40*100	55	32	40	1°PT	SDA-01300
AD-KFBSPT-40*125	55	40.5	40	1.2*PT	SDA-01301
AD-KFBSPT-40*150	55	46	40	1.5*PT	SDA-01302
AD-KFBSPT-50*150	75	46	40	1.5*PT	SDA-01303
AD-KFBSPT-50*200	75	58	40	2*PT	SDA-01304

NW\KF flange to female pipe adaptors

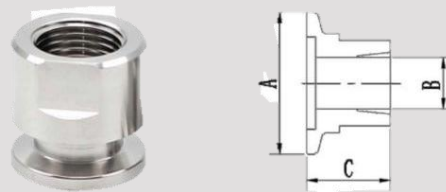

Material: SS304

Remark: SS316L is available upon request.

NPT thread is available upon request.

Model No.	A	B	C	Thread size	Part No.
AD-KFBSPTF-16*0125	30	8.8	25	1/8*PT	SDA-01305
AD-KFBSPTF-16*025	30	11.7	25	1/4*PT	SDA-01306
AD-KFBSPTF-16*0375	30	15.2	25	3/8*PT	SDA-01307

עמוד 141 מתוך 183



CONTACT

 (+972)53-938-9696

 www.sda-tech.co.il

 office@sda-tech.com

 המסגר 9, מגדל העמק, ישראל

AD-KFBSPTF-16*050	30	18.8	25	1/2*PT	SDA-01308
AD-KFBSPTF-16*M14	30	12.5	25	M14*1.5	SDA-01309
AD-KFBSPTF-16*M20	30	18.5	25	M20*1.5	SDA-01310
AD-KFBSPTF-25*025	40	11.7	25	1/4*PT	SDA-01311
AD-KFBSPTF-25*0375	40	15.2	25	3/8"PT	SDA-01312
AD-KFBSPTF-25*050	40	18.8	25	1/2"PT	SDA-01313
AD-KFBSPTF-25*075	40	24.3	25	3/4"PT	SDA-01314
AD-KFBSPTF-25*100	40	30.5	25	1*PT	SDA-01315
AD-KFBSPTF-25*M14	40	12.5	25	M14*1.5	SDA-01316
AD-KFBSPTF-25*M20	40	18.5	25	M20*1.5	SDA-01317
AD-KFBSPTF-40*050	55	18.8	25	1/2*PT	SDA-01318
AD-KFBSPTF-40*075	55	15.2	25	3/4*PT	SDA-01319
AD-KFBSPTF-40*100	55	30.5	25	1*PT	SDA-01320
AD-KFBSPTF-40*125	55	39.2	25	1.2*PT	SDA-01321
AD-KFBSPTF-40*150	55	45.1	25	1.5*PT	SDA-01322
AD-KFBSPTF-50*150	75	45.1	25	1.5*PT	SDA-01323
AD-KFBSPTF-50*200	75	56.9	25	2*PT	SDA-01324

ISO to CF Flange conical adaptor

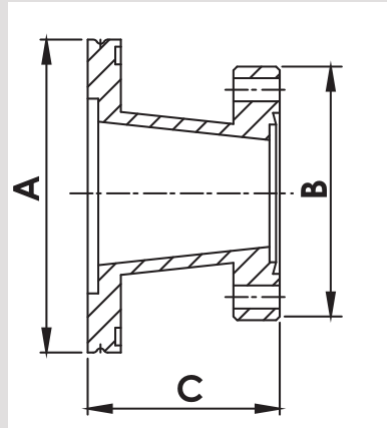

Material: SS304

Remark: SS316L is available upon request.

Model No.	A	B	C	Part No.
AD-C-ISOCF-63x35	ISO63	CF35	71.9	SDA-01325
AD-C-ISOCF-63x50	ISO63	CF50	72.3	SDA-01326
AD-C-ISOCF-63x80	ISO63	CF80	105.5	SDA-01327
AD-C-ISOCF-63x100	ISO63	CF100	109.5	SDA-01328
AD-C-ISOCF-80x35	ISO80	CF35	103.7	SDA-01329
AD-C-ISOCF-80x50	ISO80	CF50	104.1	SDA-01330
AD-C-ISOCF-80x63	ISO80	CF63	107.9	SDA-01331
AD-C-ISOCF-80x100	ISO80	CF100	109.5	SDA-01332
AD-C-ISOCF-100x50	ISO100	CF50	104.1	SDA-01333
AD-C-ISOCF-100x63	ISO100	CF63	107.9	SDA-01334
AD-C-ISOCF-100x80	ISO100	CF80	105.5	SDA-01335

KF to CF Flange conical adaptors

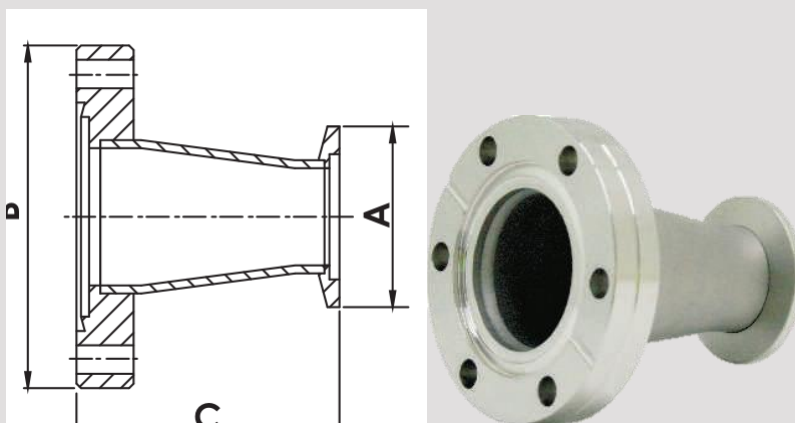

Material: SS304

Remark: SS316L is available upon request.

Model No.	A	B	C	Part No.
AD-C-KFCF-16x25	KF 16	CF25	42.9	SDA-01332
AD-C-KFCF-16x35	KF16	CF35	69.3	SDA-01333
AD-C-KFCF-25x16	KF 25	CF16	43.15	SDA-01334
AD-C-KFCF-25x35	KF 25	CF35	69.3	SDA-01335
AD-C-KFCF-25x50	KF25	CF50	69.9	SDA-01336
AD-C-KFCF-40x16	KF 40	CF16	68.55	SDA-01337
AD-C-KFCF-40x25	KF 40	CF25	68.3	SDA-01338
AD-C-KFCF-40x50	KF 40	CF50	69.9	SDA-01339
AD-C-KFCF-40x63	KF 40	CF63	73.7	SDA-01340
AD-C-KFCF-40x80	KF 40	CF80	103.1	SDA-01341
AD-C-KFCF-50x25	KF 50	CF25	68.3	SDA-01342
AD-C-KFCF-50x35	KF 50	CF35	69.3	SDA-01343
AD-C-KFCF-50x63	KF 50	CF63	73.7	SDA-01344
AD-C-KFCF-50x80	KF 50	CF80	103.1	SDA-01345
AD-C-KFCF-50x100	KF 50	CF100	106.9	SDA-01346

KF Flanges to quick couplings with Viton O-ring

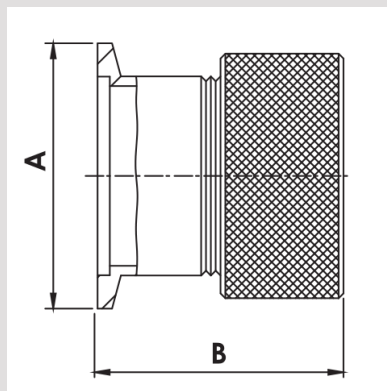

Material: SS304

Remark: SS316L is available upon request.

Model No.	Tube size	A	B	Part No.
AD-QC-KF10x050	1/2"	30	38.1	SDA-01352
AD-QC-KF16x025	1/4"	30	35.6	SDA-01353
AD-QC-KF16x050	1/2"	30	38.1	SDA-01354
AD-QC-KF16x075	3/4"	30	45.7	SDA-01355
AD-QC-KF25x050	1/2"	40	38.1	SDA-01356
AD-QC-KF25x062	5/8"	40	43.2	SDA-01357
AD-QC-KF25x075	3/4"	40	45.7	SDA-01358
AD-QC-KF25x100	1.0"	40	50.8	SDA-01359
AD-QC-KF25x112	1-1/8"	40	50.8	SDA-01360
AD-QC-KF40x050	1/2"	55	37.6	SDA-01361
AD-QC-KF40x075	3/4"	55	45.7	SDA-01362



CONTACT

 (+972)53-938-9696

 www.sda-tech.co.il

 office@sda-tech.com

 המסגר 9, מגדל העמק, ישראל

AD-QC-KF40x100	1.0"	55	50.8	SDA-01363
AD-QC-KF40x112	1-1/8"	55	50.8	SDA-01364
AD-QC-KF40x125	1-1/4"	55	50.8	SDA-01365
AD-QC-KF40x138	1-3/8"	55	53.3	SDA-01366
AD-QC-KF40x150	1-1/2"	55	61	SDA-01367
AD-QC-KF50x050	1 /2"	75	38.1	SDA-01368
AD-QC-KF50x075	3 /4"	75	45.7	SDA-01369
AD-QC-KF50x100	1.0"	75	50.8	SDA-01370
AD-QC-KF50x112	1-1/8"	75	50.8	SDA-01371
AD-QC-KF50x150	1-1/2"	75	61	SDA-01372
AD-QC-KF50x200	2.0"	75	61	SDA-01373

Vacuum Valves



Materials:

Valve body: SS304 or SS316L based on request.

Sealing.

Material:

PTFE, formed bellow, welded bellow, Viton, NBR for selection.

Leak tests are taken based on requirements.

חומרי שסתומים ואטמים

גוף השסתום מיוצר מנירוסטה SS304 או SS316L לפי דרישת הלקוח.
חומרי האטימה כוללים, PTFE, מפוח מעוצב, מפוח מרותך Viton, ו-NBR -
לבחירה בהתאם לצורך.
בדיקות דליפה מבוצעות לפי דרישות הלקוח.



CONTACT

 (+972)53-938-9696

 www.sda-tech.co.il

 office@sda-tech.com

 המסגר 9, מגדל העמק, ישראל

GU Manual ball valve KF(3-piece)

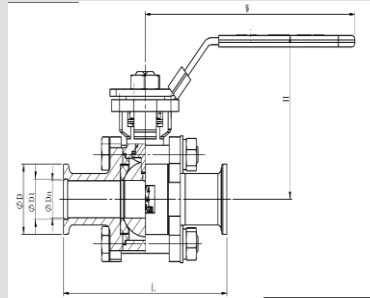

Model No.	D	D1	Dn	L	W	H	Part No.
GU-16-KF	30	17.2	15.8	102	130	69	SDA-01374
GU-25-KF	40	26.2	22.1	115	170	92	SDA-01375
GU-40-KF	55	41.2	34.8	138	170	99	SDA-01376
GU-50-KF	75	52.2	47.5	156	173	118	SDA-01377

GU Pneumatic ball valve KF

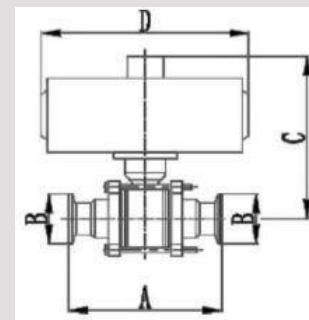

Material : SS304 for valve body and PTFE for sealing gasket.

Remark: SS316L valve body is available upon request.

Model No.	A	B	C	D	Part No.
GU-16-KF	102	30	131	155	SDA-01378

עמוד 148 מתוך 183



CONTACT

 (+972)53-938-9696

 www.sda-tech.co.il

 office@sda-tech.com

 המסגר 9, מגדל העמק, ישראל

GU-25-KF	115	40	157	168	SDA-01379
GU-40-KF	138	55	195	219	SDA-01380
GU-50-KF	156	75	201	219	SDA-01381

Manual three-way ball valve KF

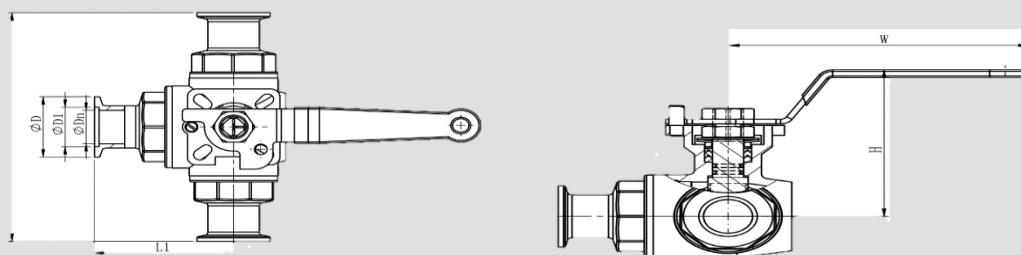

Material : SS304 for valve body and PTFE for sealing gasket.

Remark: SS316L valve body is available upon request.

Model No.	D	D1	Dn	L	L1	W	H	Part No.
GU-16-KF	30	17.2	15.8	122	61	135	79	SDA-01382
GU-25-KF	40	26.2	22.1	152	76	135	96	SDA-01383
GU-40-KF	55	41.2	34.8	175	87.5	181	118	SDA-01384
GU-50-KF	75	52.2	47.5	200	100	181	121	SDA-01385



CONTACT

 (+972)53-938-9696

 www.sda-tech.co.il

 office@sda-tech.com

 המסגר 9, מגדל העמק, ישראל

GU Pneumatic 3-way ball valve KF

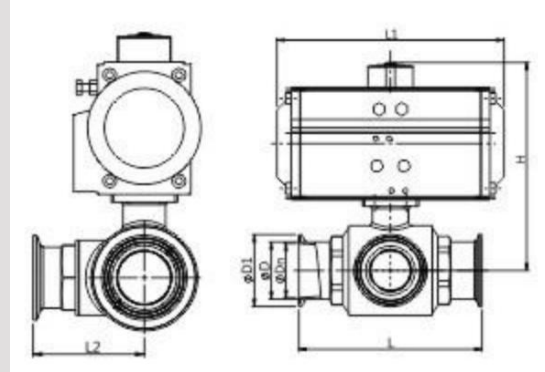

Material : SS304 for valve body and PTFE for sealing gasket.

Remark: SS316L valve body is available upon request.

Model No.	D1	D	Dn	L	L1	L2	H	Part No.
GU-16-KF	30	17.2	15.8	101	155	55	123	SDA-01386
GU-25-KF	40	26.2	22.1	120	155	61	132	SDA-01387
GU-40-KF	55	41.2	34.8	153	168	65	153	SDA-01388
GU-50-KF	75	52.2	47.5	164	219	84	185	SDA-01389



CONTACT

 (+972)53-938-9696

 www.sda-tech.co.il

 office@sda-tech.com

 המסגר 9, מגדל העמק, ישראל

GD Manual angle valve-welding port

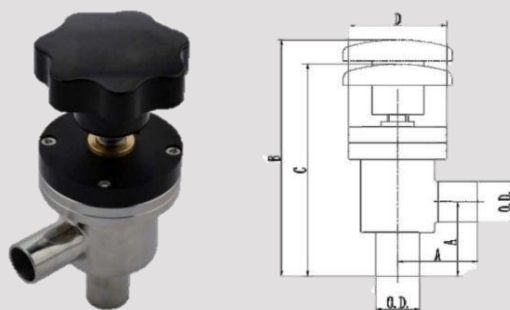

Material : SS304 for valve body and formed bellow for sealing.

Remark: Welded bellow for sealing is available upon request.

Model No.	Standard	O.D.	A	B	C	D	Part No.
GD-J16	US	19.05	50.8	150	134	63	SDA-01390
GD-J25	US	25.4	47.75	147	131	63	SDA-01391
GD-J40	US	38.1	57.15	174	155	78	SDA-01392
GD-J50	US	50.8	82.55	220	200	88	SDA-01393
GD-J63	US	63.5	76.2	242.4	217.4	101.6	SDA-01394
GD-J80	US	76.2	82.55	273.4	243.4	114	SDA-01395
GD-J16	EU	19.05	36.2	139.2	123.2	63	SDA-01397
GD-J25	EU	25.4	46.2	149.2	133.2	63	SDA-01398
GD-J40	EU	38.1	61.2	181.7	162.7	78	SDA-01399
GD-J50	EU	50.8	66.2	207.4	187.4	88	SDA-01400
GD-J63	EU	63.5	81.5	254.2	229.2	101.6	SDA-01401
GD-J80	EU	76.2	91.5	288.9	258.9	114	SDA-01402



CONTACT

 (+972)53-938-9696

 www.sda-tech.co.il

 office@sda-tech.com

 המסגר 9, מגדל העמק, ישראל

GD Manual angle valve-KF

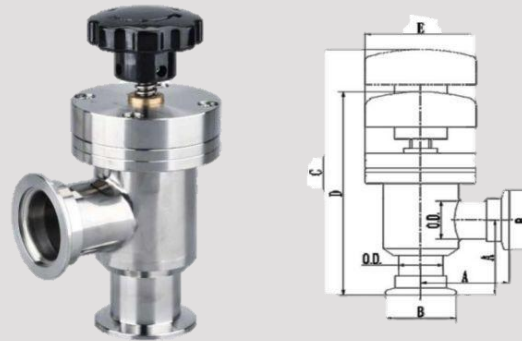

Material : SS304 for valve body and formed bellow for sealing.

Remark: Welded bellow for sealing is available upon request.

Model No.	Standard	O.D.	A	B	C	D	E	Part No.
GD-J16-KF	US	19.05	50.8	30	153.8	137.8	63	SDA-01403
GD-J25-KF	US	25.4	47.8	40	150.8	134.8	63	SDA-01404
GD-J40-KF	US	38.1	57.2	55	177.7	158.7	78	SDA-01405
GD-J50-KF	US	50.8	82.6	75	223.8	203.8	88	SDA-01406
GD-J63-KF	US	63.5	76.2	87	246.2	221.2	101.6	SDA-01407
GD-J80-KF	US	76.2	82.6	114	279.9	249.9	114	SDA-01408
GD-J16-KF	EU	19.05	40	30	143	127	63	SDA-01410
GD-J25-KF	EU	25.4	50	40	153	137	63	SDA-01411
GD-J40-KF	EU	38.1	65	55	185.5	166.5	78	SDA-01412
GD-J50-KF	EU	50.8	70	75	211.2	191.2	88	SDA-01413
GD-J63-KF	EU	63.5	88	87	258	233	101.6	SDA-01414
GD-J80-KF	EU	76.2	98	114	295.4	265.4	114	SDA-01415

ISO Manual angle valve

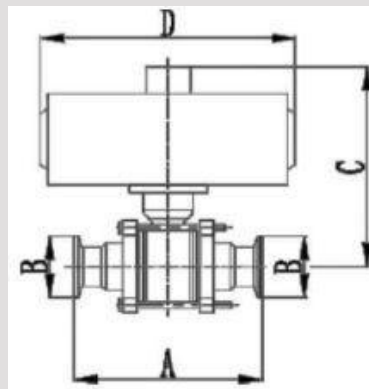
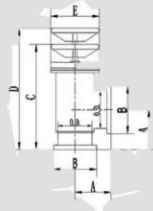

Material : SS304 for valve body and formed bellow for sealing.

Remark:

1. Welded bellow or Viton O-ring for sealing is available upon request.
2. A rotatable flange can be added outside the ISO flange if required.

Model No.	Standard	O.D.	A	B	C	D	E	Part No.
GD-J63-ISO	usual	63.5	88	95	233	250	101.6	SDA-01416
GD-J80-ISO	usual	76.2	98	110	265	285	114	SDA-01417
GD-J100-ISO	usual	101.6	108	130	285	313	145.8	SDA-01418
GD-J160-ISO	usual	152.4	138	180	375	412	204	SDA-01419
GD-J200-ISO	usual	204	200	240	435	487	254	SDA-01420
GD-J250-ISO	usual	254	208	290	495	95	306	SDA-01421
Flange size	F	G	No.H		P.C. D	1	J	T
ISO63	130	12	9*4		110	75	87.6	3.7
ISO80	145	12	9*8		125	88.5	101.1	3.7
ISO100	165	12	9*8		145	107.5	120.1	3.7
ISO160	225	16	11*8		200	160	172.8	3.7
ISO200	285	16	11*8		260	224	236.6	3.7
ISO250	335	16	11*8		310	266	278.6	3.7



CONTACT

 (+972)53-938-9696

 www.sda-tech.co.il

 office@sda-tech.com

 המסגר 9, מגדל העמק, ישראל

CF Manual angle valve

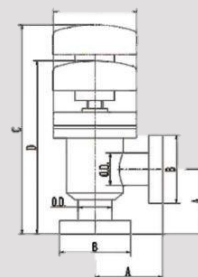

Material : SS304 for valve body and 350 welded bellow for sealing.

Remark: 1.A rotatable flange can be applied based on required.

Model No.	O.D.	A	B	C	D	E	Part No.
GD-J16-CF	19.05	54.1	34	153.3	137.3	63	SDA-01422
GD-J25-CF	25.4	52.8	54	152	136	63	SDA-01423
GD-J35-CF	38.1	62.7	70	179.5	160.5	78	SDA-01424
GD-J50-CF	50.8	90.6	86	228	208	88	SDA-01425
GD-J63-CF	63.5	85.7	114	251.9	226.9	101.6	SDA-01426
GD-J80-CF	76.2	92.6	130	283.4	253.4	114	SDA-01427

GD Pneumatic thin angle valve-welding port

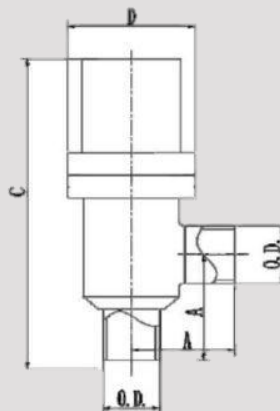

Material : SS304 for valve body and formed bellow for sealing.

Remark:

1. Welded bellow for sealing is available upon request.
2. different cylinders could be supplied based on request. Please contact with sales for more information.

Model No.	Standard	O.D.	A	C	D	Part No.
GD-J16	US	19.05	47	159.6	63	SDA-01428
GD-J25	US	25.4	44	143.95	63	SDA-01429
GD-J40	US	38.1	53.35	175.55	78	SDA-01430
GD-J50	US	50.8	78.75	214.3	88	SDA-01431
GD-J63	US	63.5	72.4	235.2	101.6	SDA-01432
GD-J80	US	76.2	76.1	274.3	114	SDA-01433



CONTACT

 (+972)53-938-9696

 www.sda-tech.co.il

 office@sda-tech.com

 המסגר 9, מגדל העמק, ישראל

GD-J16	EU	19.05	36.2	145	63	SDA-01435
GD-J25	EU	25.4	46.2	146.2	63	SDA-01436
GD-J40	EU	38.1	61.2	183.4	78	SDA-01428
GD-J50	EU	50.8	66.2	198.3	88	SDA-01429
GD-J63	EU	63.5	84.2	247	101.6	SDA-01430
GD-J80	EU	76.2	91.5	289.7	114	SDA-01431

GDQ Pneumatic thin angle valve KF

Material : SS304 for valve body and formed bellow for sealing.

Remark:

1. Welded bellow for sealing is available upon request.

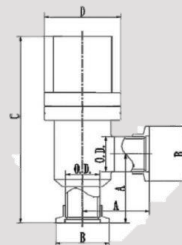

2. different cylinders could be supplied based on request. Please contact with sales for more information.

Model No.	Standard	O.D.	A	B	C	D	Part No.
GDQ-J16-KF	US	19.05	50.8	30	159.6	63	SDA-01432
GDQ-J25-KF	US	25.4	47.75	40	143.95	63	SDA-01433
GDQ-J40-KF	US	38.1	57.15	55	175.55	78	SDA-01434
GDQ-J50-KF	US	50.8	82.55	75	214.3	88	SDA-01435
GDQ-J63-KF	US	63.5	76.2	87	235.2	101.6	SDA-01436
GDQ-J80-KF	US	76.2	82.55	114	274.25	114	SDA-01437
GDQ-J16-KF	EU	19.05	40	30	145	63	SDA-01439
GDQ-J25-KF	EU	25.4	50	40	146.2	63	SDA-01440
GDQ-J40-KF	EU	38.1	65	55	183.4	78	SDA-01441
GDQ-J50-KF	EU	50.8	70	75	198.3	88	SDA-01442
GDQ-J63-KF	EU	63.5	88	87	247	101.6	SDA-01443
GDQ-J80-KF	EU	76.2	98	114	289.7	114	SDA-01444

GDQ Pneumatic thin angle valve-ISO

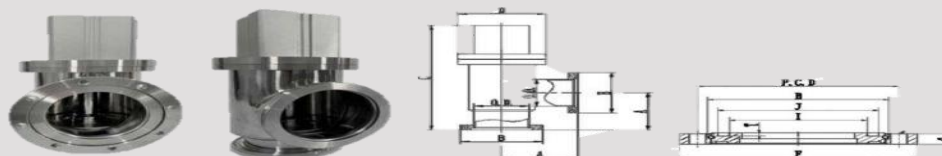

Material : SS304 for valve body and formed bellow for sealing. Remark:

1. Welded bellow or Viton O-ring for sealing is available upon request.
2. A rotatable flange can be added outside the ISO flange if required.
3. Different cylinders could be supplied based on request. Please contact with sales for more information.

Model no.	Standard	O.D.	A	B	C	D	Part no.
GDQ-J63-ISO	usual	63.5	88	95	247	101.6	SDA-01445
GDQ-J80-ISO	usual	76.2	98	110	290	114	SDA-01446
GDQ-J100-ISO	usual	101.6	108	130	334	145.8	SDA-01447
GDQ-J160-ISO	usual	152.4	138	180	455	204	SDA-01448
GDQ-J200-ISO	usual	204	200	240	609	254	SDA-01449
GDQ-J250-ISO	usual	254	208	290	737	306	SDA-01450
Flange size	F	G	ON.H	P.C. D	1	J	T
ISO63	130	12	9*4	110	75	87.6	3.7
ISO80	145	12	9*8	125	88.5	101.1	3.7
ISO100	165	12	9*8	145	107.5	120.1	3.7
ISO160	225	16	11*8	200	160	172.8	3.7
ISO200	285	16	11*8	260	224	236.6	3.7
ISO250	335	16	11*8	310	266	278.6	3.7



CONTACT

 (+972)53-938-9696

 www.sda-tech.co.il

 office@sda-tech.com

 המסגר 9, מגדל העמק, ישראל

Manual air release valve

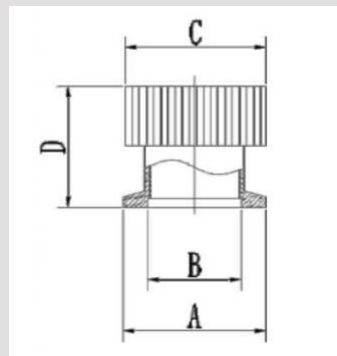

Material : SS304 for valve body and Viton O-ring for sealing.

Model No.	A	B	C	D	Part No.
GD-Q16	30	17.2	26	39	SDA-01553
GD-Q25	40	26.2	26	39	SDA-01554
GD-Q40	55	41.2	26	39	SDA-01555

GDQ Pneumatic thin angle valve-CF

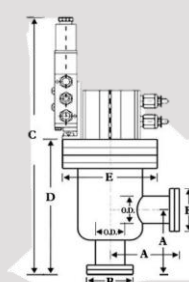
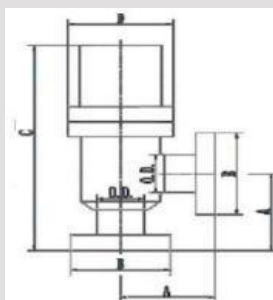

Material : SS304 for valve body and 350 welded bellow for sealing.

Remark:

- 1.A rotatable flange can be applied based on required.
- 2.Different cylinders could be supplied based on request. Please contact with sales for more information.

Model No.	O.D.	A	B	C	D	Part No.
GDQ-J16-CF	19.05	54.1	34	160.1	63	SDA-01451

עמוד 159 מתוך 183



CONTACT

 (+972)53-938-9696

 www.sda-tech.co.il

 office@sda-tech.com

 המסגר 9, מגדל העמק, ישראל

GDQ-J25-CF	25.4	52.8	54	145.2	63	SDA-01452
GDQ-J35-CF	38.1	62.7	70	177.3	78	SDA-01453
GDQ-J50-CF	50.8	90.6	86	218.5	88	SDA-01454
GDQ-J63-CF	63.5	85.7	114	240.9	101.6	SDA-01455
GDQ-J80-CF	76.2	92.6	130	277.8	114	SDA-01456

GD Manual Y-type valve-welding port

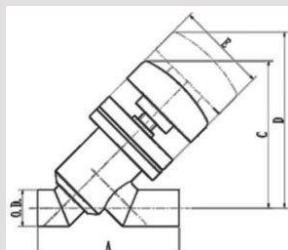

Material : SS304 for valve body and formed bellow for sealing.

Remark: Welded bellow for sealing is available upon request.

Model No.	O.D.	A	C	D	E	Part No.
GD-Y16	19.05	94	102.4	109.5	63	SDA-01457
GD-Y25	25.4	99.1	102.4	109.5	63	SDA-01458
GD-Y40	38.1	122.4	121.7	132.3	78	SDA-01459
GD-Y50	50.8	170.2	142.8	156.9	88	SDA-01460

GD Manual Y-type valve-KF

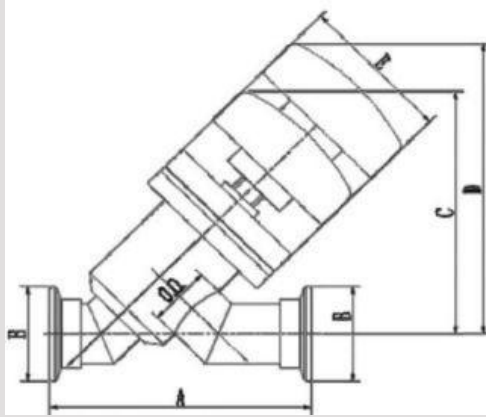

Material : SS304 for valve body and formed bellow for sealing.

Remark: Welded bellow for sealing is available upon request.

Model No.	O.D.	A	B	C	D	E	Part No.
GD-Y16-KF	19.05	101.6	30	102.4	109.5	63	SDA-01461
GD-Y25-KF	25.4	106.7	40	102.4	109.5	63	SDA-01462
GD-Y40-KF	38.1	130	55	121.7	132.3	78	SDA-01463
GD-Y50-KF	50.8	177.8	75	142.8	156.9	88	SDA-01464

GD Manual Y-type valve-CF

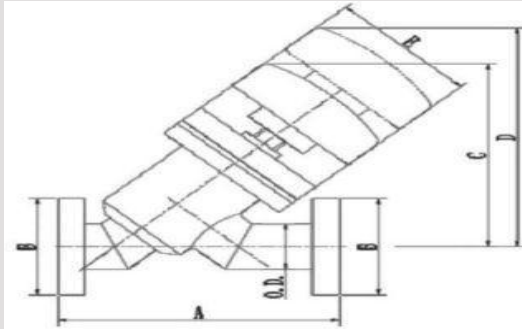

Material : SS304 for valve body and 350 welded bellow for sealing.

Remark:1. A rotatable flange can be applied based on required.

Model No.	O.D.	A	B	C	D	E	Part No.
GD-Y16-CF	19.05	102.6	34	102.4	109.5	63	SDA-01465
GD-Y25-CF	25.4	109.1	54	102.4	109.5	63	SDA-01466
GD-Y40-CF	38.1	133.4	70	121.7	132.3	78	SDA-01467
GD-Y50-CF	50.8	186.2	86	142.8	156.9	88	SDA-01468

GDQ Pneumatic thin Y-type valve-welding port

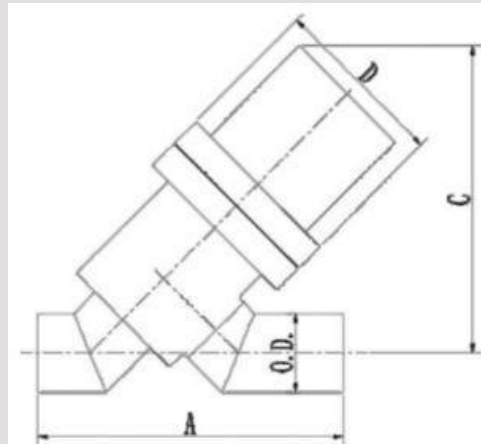

Material : SS304 for valve body and formed bellow for sealing.

Remark:

1. Welded bellow for sealing is available upon request.
2. different cylinders could be supplied based on request. Please contact with sales for more information.

Model No.	O.D.	A	C	D	Part No.
GDQ-Y16	19.05	94	99.1	63	SDA-01469
GDQ-Y25	25.4	99.1	99.1	63	SDA-01470
GDQ-Y40	38.1	122.4	136.2	78	SDA-01471
GDQ-Y50	50.8	170.2	154	88	SDA-01472



CONTACT

 (+972)53-938-9696

 www.sda-tech.co.il

 office@sda-tech.com

 המסגר 9, מגדל העמק, ישראל

GDQ Pneumatic thin Y-type valve-KF

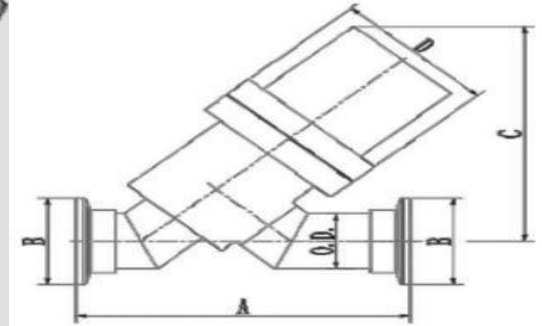

Material : SS304 for valve body and formed bellow for sealing. Remark:

- 1.Welded bellow for sealing is available upon request.
- 2.different cylinders could be supplied based on request. Please contact with sales for more information.

Model No.	O.D.	A	B	C	D	Part No.
GDQ-Y16	19.05	101.6	30	99.1	63	SDA-01473
GDQ-Y25	25.4	106.7	40	99.1	63	SDA-01474
GDQ-Y40	38.1	130	55	136.2	78	SDA-01475
GDQ-Y50	50.8	177.8	75	154	88	SDA-01476

GDQ Pneumatic thin Y-type valve-CF

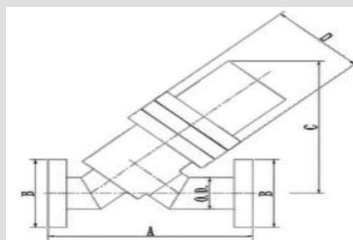

Material : SS304 for valve body and 350 welded bellow for sealing.

Remark:

- 1.A rotatable flange can be applied based on required.
- 2.Different cylinders could be supplied based on request. Please contact with sales for more information.

Model No.	O.D.	A	B	C	D	Part No.
GDQ-Y16-KF	19.05	102.6	34	99.1	63	SDA-01477
GDQ-Y25-KF	25.4	109.1	54	99.1	63	SDA-01478
GDQ-Y40-KF	38.1	133.4	70	136.2	78	SDA-01479
GDQ-Y50-KF	50.8	186.2	86	154	88	SDA-01480

Manual Z-valve-KF

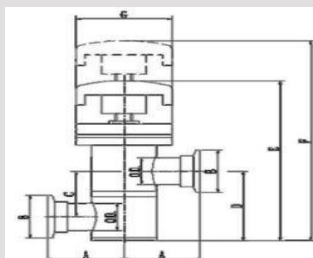

Material : SS304 for valve body and formed bellow for sealing.

Remark: Welded bellow for sealing is available upon request.

Model No.	O.C. D	A	B	C	D	E	F	G	Part No.
GD-Z16-KF	19.05	40	30	28	48	135	154	63	SDA-01481



CONTACT

 (+972)53-938-9696

 www.sda-tech.co.il

 office@sda-tech.com

 המסגר 9, מגדל העמק, ישראל

GD-Z25-KF	25.4	50	40	35	58	141	160	63	SDA-01482
GD-Z40-KF	38.1	65	55	48	77	178	197	78	SDA-01483
GD-Z50-KF	50.8	70	75	66	101	224	244	88	SDA-01484

Manual Z-valve-CF

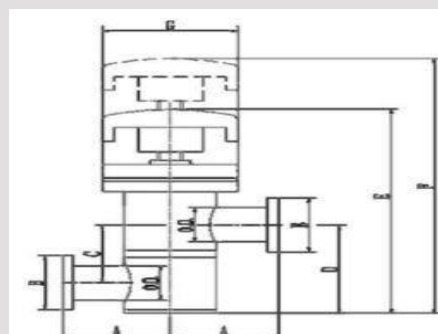

Material : SS304 for valve body and 350 welded bellow for sealing.

Remark:1. A rotatable flange can be applied based on required.

Model No.	O. D	A	B	C	D	E	F	G	Part No.
GD-Z16-CF	19.05	54.1	34	28	48	135	154	63	SDA-01485
GD-Z25-CF	25.4	52.8	54	35	58	141	160	63	SDA-01486
GD-Z35-CF	38.1	62.7	70	48	77	178	197	78	SDA-01487
GD-Z50-CF	50.8	90.6	86	66	101	224	244	88	SDA-01488



CONTACT

 (+972)53-938-9696

 www.sda-tech.co.il

 office@sda-tech.com

 המסגר 9, מגדל העמק, ישראל

Pneumatic Z-valve-KF

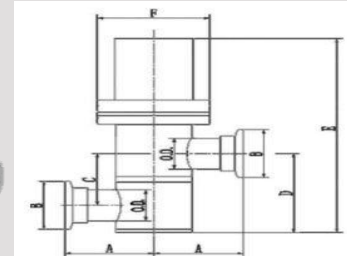

Material : SS304 for valve body and formed bellow for sealing.

Remark:

- 1.Welded bellow for sealing is available upon request.
- 2.different cylinders could be supplied based on request. Please contact with sales for more information.

Model No.	O. D	A	B	C	D	E	F	G	Part No.
GDQ-Z16-KF	19.1	40	30	28	48	135	154	63	SDA-01489
GDQ-Z25-KF	25.4	50	40	35	58	141	160	63	SDA-01490
GDQ-Z40-KF	38.1	65	40	48	77	178	197	78	SDA-01491
GDQ-Z50-KF	50.8	70	75	66	101	224	244	88	SDA-01492



CONTACT

 (+972)53-938-9696

 www.sda-tech.co.il

 office@sda-tech.com

 המסגר 9, מגדל העמק, ישראל

Manual Z-valve-CF

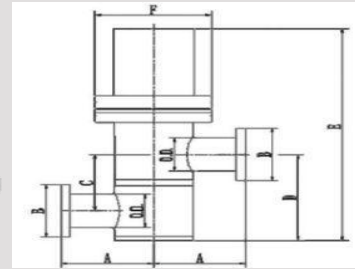

Material : SS304 for valve body and 350 welded bellow for sealing.

Remark:1. A rotatable flange can be applied based on required.

Model No.	O. D	A	B	C	D	E	F	G	Part No.
GDQ-Z16-CF	19.1	54.1	34	28	48	135	154	63	SDA-01493
GDQ-Z25-CF	25.4	52.8	54	35	58	141	160	63	SDA-01494
GDQ-Z35-CF	38.1	62.7	70	48	77	178	197	78	SDA-01495
GDQ-Z50-CF	50.8	90.6	86	66	101	224	244	88	SDA-01496



CONTACT

 (+972)53-938-9696

 www.sda-tech.co.il

 office@sda-tech.com

 המסגר 9, מגדל העמק, ישראל

GI Manual butterfly valve

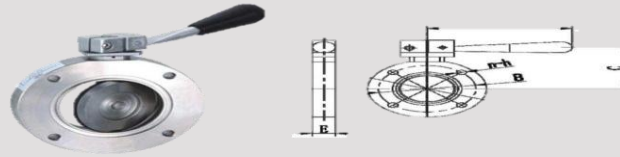

Material : SS304 for valve body

Remark: SS316L could be supplied based on request.

Model No.	A	B	C	D	E	N-h	Part No.
GI-25	70	55	64	104	22	4-7	SDA-01497
GI-32	78	64	68	104	22	4-7	SDA-01498
GI-40	85	70	72	116	22	4-7	SDA-01499
GI-50	110	90	85	116	22	4-9	SDA-01500
GI-63	125	105	94	132	26	4-9	SDA-01501
GI-80	145	125	108	154	30	4-9	SDA-01502
GI-100	170	145	120	154	30	4-12	SDA-01503
GI-125	195	170	136	197	35	4-12	SDA-01504
GI-160	220	195	150	197	35	8-12	SDA-01505
GI-200	275	250	185	242	40	8-12	SDA-01506
GI-250	330	300	219	330	45	8-14	SDA-01507
GI-300	380	350	245	330	55	8-14	SDA-01508
GI-400	500	465	312	435	60	8-18	SDA-01509

GIQ Pneumatic butterfly valve

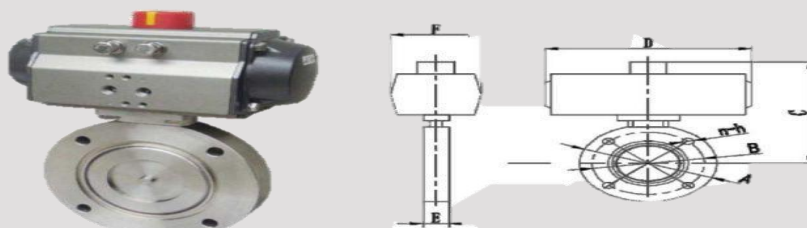

Material : SS304 for valve body

Remark: SS316L could be supplied based on request.

Model No.	A	B	C	D	E	F	n-h	Part No.
GIQ-25	70	55	152	168	22	92	4-7	SDA-01510
GIQ-32	78	64	156	168	22	92	4-7	SDA-01511
GIQ-40	85	70	159	168	22	92	4-7	SDA-01512
GIQ-50	110	90	181	168	22	92	4-9	SDA-01513
GIQ-63	125	105	207	168	26	92	4-9	SDA-01514
GIQ-80	145	125	230	204	30	105	4-9	SDA-01515
GIQ-100	170	145	242	204	30	105	4-12	SDA-01516
GIQ-125	195	170	288	204	35	105	4-12	SDA-01517
GIQ-160	220	195	299	268	35	140	8-12	SDA-01518
GIQ-200	275	250	348	298	40	168	8-12	SDA-01519
GIQ-250	330	300	419	458	45	200	8-14	SDA-01520
GIQ-300	380	350	475	525	55	231	8-14	SDA-01521
GIQ-400	500	465	557	532	60	251	8-18	SDA-01522
GIQ-500	600	565	650	722	80	324	12-18	SDA-01523
GIQ-600	710	670	728	742	100	354	12-21	SDA-01524
GIQ-800	920	880	882	860	130	410	20-21	SDA-01525

Manual diaphragm valve-welding port

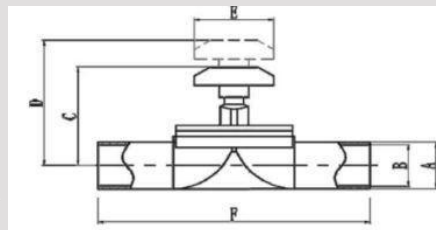

Material : SS304 for valve body

Remark: SS316L could be supplied based on request.

Model No.	A	B	C	D	E	F	Part No.
GM-10	17	10	89	99	65	75	SDA-01526
GM-25	32	25	110	123	80	120	SDA-01527
GM-40	45	40	139	159	120	150	SDA-01528
GM-50	57	50	159	186	120	180	SDA-01529

Manual diaphragm valve-KF

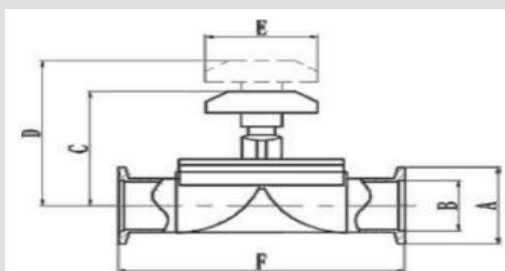

Material : SS304 for valve body

Remark: SS316L could be supplied based on request.

Model No.	A	B	C	D	E	F	Part No.
GM-10	30	12.2	89	99	65	75	SDA-01530
GM-16	30	17.2	89	99	80	108	SDA-01531



CONTACT

 (+972)53-938-9696

 www.sda-tech.co.il

 office@sda-tech.com

 המסגר 9, מגדל העמק, ישראל

GM-20	40	22.2	91	102	80	118	SDA-01532
GM-25	40	26.2	110	123	80	120	SDA-01533
GM-32	55	34.2	129	138	80	146	SDA-01534
GM-40	55	41.2	139	159	120	150	SDA-01535
GM-50	75	52.2	159	186	120	180	SDA-01536

Vacuum fine tuning valve.

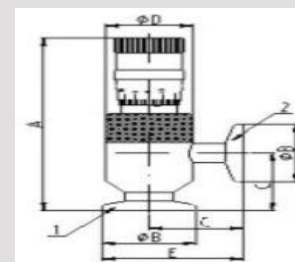
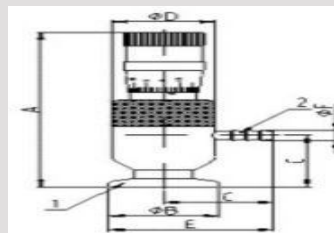

Model No.	Diameter	Flange type	A	B	C	D	E	F	G	Part No.
GW-J2	0.8	KF	90	30	30	28	45	-	43	SDA -01537
GW-J2	0.8	KF	90	30	30	28	45	6	43	SDA-01538
GW-J4	1.2	KF	93	30	30	28	45	-	53	SDA-01539
GW-J4	1.2	KF	93	30	30	28	45	6	66	SDA-01540



CONTACT

 (+972)53-938-9696

 www.sda-tech.co.il

 office@sda-tech.com

 המסגר 9, מגדל העמק, ישראל

Pneumatic gate valve-CF

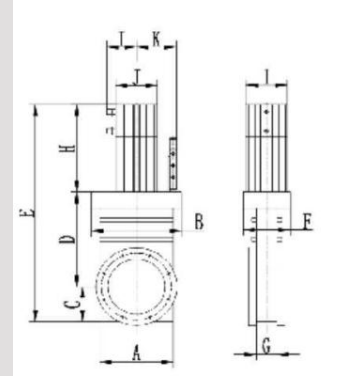

Material : SS304 for valve body and 350 welded bellow for sealing.

Model No.	A	B	C	D	E	F	G	H	I	J	K	L	Part No.
CCQ-63B	110	130	52	173	366	64	34	141	64	72	64	61	SDA-01541
CCQ-80B	130	140	57	228	447	75	36	162	77	84	73	68	SDA-01542
CCQ-100B	151	178	75	228	482	75	36	179	77	84	73	68	SDA-01543
CCQ-160B	201	228	96	302	613	75	41	215	77	84	83	68	SDA-01544
CCQ-200B	248	276	120	380	730	75	42	230	98	104	93	77	SDA-01545
CCQ-250B	310	342	146	463	812	80	48	203	117	124	98	86	SDA-01546

Manual gate valve-CF

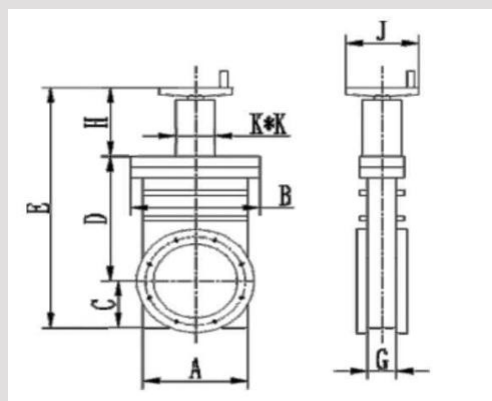

Material : SS304 for valve body and 350 welded bellow for sealing.

Model No.	A	B	C	D	E	F	G	H	1	J	K	Part No.
CC-63B	110	130	52	173	378	64	34	153	56	100	64	SDA-01547
CC-80B	130	140	57	228	462	75	36	177	69	100	75	SDA-01548
CC-100B	151	178	75	228	487	75	36	184	69	100	75	SDA-01549
CC-160B	201	228	96	302	605	75	41	207	69	100	75	SDA-01550
CC-200B	248	276	120	380	714	75	42	214	69	125	75	SDA-01551
CC-250B	310	342	146	463	875	80	48	266	70	125	80	SDA-01552



CONTACT

 (+972)53-938-9696

 www.sda-tech.co.il

 office@sda-tech.com

 המסגר 9, מגדל העמק, ישראל

Vacuum Chambers

A vacuum chamber is a container that maintains a vacuum state inside. The production of a vacuum chamber should consider volume, material, and shape.

Stainless steel is currently the main structural material for ultra-high vacuum systems. It has excellent corrosion resistance, low gas release rate, no magnetism, good weldability, low conductivity, and thermal conductivity, and can work at -270-900 °C. It is widely used in high vacuum and ultra-high vacuum systems.

Commonly used materials include stainless steel, aluminum alloy, carbon steel, etc., which involve surface treatment such as welding, sandblasting, polishing, electrolytic polishing, anodizing, etc. Additionally, heat treatment stress relief or vibration stress relief can be carried out according to customer needs, providing customers with more complete vacuum process solutions.

תאי ואקום Vacuum Chambers –

תא ואקום הוא מיכל שמאפשר שמירה על מצב ואקום פנימי. החומרים הנפוצים לייצור כוללים נירוסטה, סגסוגת אלומיניום ופלדה, בהתאם לנפח, חומר וצורה נדרשים.

נירוסטה היא החומר העיקרי למערכות ואקום גבוה במיוחד, בזכות עמידות בפני קורוזיה, קצב שחרור גזים נמוך, ריתוכיות טובה, וללא מגנטיות. מתאימה לעבודה בטווח טמפרטורות של -270°C עד 900°C. תהליכי גמר כוללים ריתוך, ליטוש, התזת חול, אלקטרוליט ליטוש, אנודיזציה וטיפולי הקלה במאמצים – תרמיים או רטטיים – לפי דרישת הלקוח.

CF Viewport (Sightless)

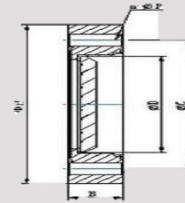

Specifications

Leakage rate : $< 10^{-8} \text{Pa-L/S}$

Baking resistance temperature : $\leq 350^{\circ}\text{C}$

All are sealed with oxygen free copper gasket. Application It is used for ultra-high vacuum instruments and equipment and can clearly observe the internal conditions of the system from the outside.

Glass can be used as fluorescent screen after being coated.

Model No.	ΦH	ΦC	ΦD	n- ΦP	B	Part No.
CF-VP-16	34	27	14	6- $\Phi 4.3$	18	SDA-01555
CF-VP-25	54	43	23	6- $\Phi 6.6$	14	SDA-01556
CF-VP-35	70	58.7	38	6- $\Phi 6.6$	16	SDA-01557
CF-VP-50	86	72.4	50	8- $\Phi 8.4$	17	SDA-01558
CF-VP-63	114	92.2	62	8- $\Phi 8.4$	20	SDA-01559
CF-VP-100	152	130.3	95	16- $\Phi 8.4$	20	SDA-01560
CF-VP-150	202	181.1	146	20- $\Phi 8.4$	22	SDA-01561
CF-VP-200	253	231.9	193	24- $\Phi 8.4$	24.5	SDA-01562



CONTACT

 (+972)53-938-9696

 www.sda-tech.co.il

 office@sda-tech.com

 המסגר 9, מגדל העמק, ישראל

שמן / OIL



עמוד 177 מתוך 183



CONTACT

 (+972)53-938-9696

 www.sda-tech.co.il

 office@sda-tech.com

 המסגר 9, מגדל העמק, ישראל

Ultragrade Performance 19/72 Vacuum Oil



Ultragrade 19 - שמן מינרלי בצמיגות בינונית, מיועד למשאבות ואקום רגילות וקטנות.

Ultragrade 72 - שמן בצמיגות גבוהה, מותאם למשאבות ואקום כבדות או תעשייתיות הפועלות לאורך זמן ובתנאי עומס גבוה.

Model No.	צמיגות C (cSt)40°	לחץ אדים C 20° (mbar)	נקודת הבזק (°C)	Part No.
Ultragrade 19	48.6	1×10^{-8}	230	OIL-0045
Ultragrade 72	70	2.1×10^{-7}	230	OIL-0001



CONTACT

 (+972)53-938-9696

 www.sda-tech.co.il

 office@sda-tech.com

 המסגר 9, מגדל העמק, ישראל

Fomblin Oil 06/6, 16/6, 25/6 (שמן פומבלין)



OIL-0019

שמן פומבלין
Fomblin Oil PFPE 06/6



WWW.SDA-TECH.COM

052-396-2356

OFFICE@SDA-TECH.COM

OIL-0023

שמן פומבלין
Fomblin Oil PFPE 16/6



WWW.SDA-TECH.COM

052-396-2356

OFFICE@SDA-TECH.COM

OIL-0010

שמן פומבלין
Fomblin Oil PFPE 25/6



WWW.SDA-TECH.COM

052-396-2356

OFFICE@SDA-TECH.COM

שמנים ממשפחת **Fomblin Y LVAC** הם שמנים מבוססי PFPE (פוליפרפלוואוראתר), אשר מתאימים במיוחד לשימוש במשאבות ואקום הפועלות בתנאים קיצוניים. השמנים אינם דליקים, עמידים כימית, בעלי לחץ אדים נמוך במיוחד – ומתאימים לסביבות בהן דרושה אמינות גבוהה וללא גזים מזהמים.

Fomblin 06/6 - שמן דל-צמיגות, מתאים ליישומים כלליים בטמפרטורות נמוכות.

Fomblin 16/6 - שמן בינוני-צמיגות, איזון טוב בין זרימה וביצועים בוואקום גבוה.

Fomblin 25/6 - שמן בצמיגות גבוהה, מתאים למשאבות הפועלות לאורך זמן בתנאי עומס חום.

Model No.	צמיגות 40°C (cSt)	לחץ אדים 20°C (mbar)	נקודת הבזק (°C)	Part No.
Fomblin 06/6	64	8×10^{-7}	50-	OIL-0019
Fomblin 16/6	168	5×10^{-9}	45-	OIL-0023
Fomblin 25/6	276	5.33×10^{-8}	35-	OIL-0010



CONTACT

 (+972)53-938-9696

 www.sda-tech.co.il

 office@sda-tech.com

 המסגר 9, מגדל העמק, ישראל

OIL 68/10



OIL-100 - שמן סיכה מינרלי בצמיגות גבוהה, מיועד למערכות הדורשות עמידות בחום גבוה ולחצים קשים, כגון מדחסים תעשייתיים או מערכות הידראוליות כבדות.

OIL-68 - שמן סיכה בצמיגות בינונית, מתאים למערכות כלליות כמו ציוד הידראולי, מסבים ומשאבות, שבהן דרושה זרימה טובה יותר בטמפ' נמוכות.

Model No.	צמיגות 40°C (cSt)	לחץ אדים 20°C (mbar)	נקודת הבזק (°C)	Part No.
OIL-100	100	5.0×10^{-3}	240	OIL-0028
OIL-68	68	1×10^{-2}	210	OIL-0029



CONTACT

 (+972)53-938-9696

 www.sda-tech.co.il

 office@sda-tech.com

 המסגר 9, מגדל העמק, ישראל

OIL MIL'S MV99'S



שמן סינתטי למשאבות ואקום, מתאים במיוחד למשאבות להב סיבובי (Rotary Vane) למשאבות MIL'S. מעניק לחץ אדים נמוך במיוחד, יציבות תרמית גבוהה, ואורך חיים ממושך.

Model No.	צמיגות 40°C (cSt) C	לחץ אדים 20°C (mbar) C	נקודת הבזק (°C)	Part No.
MV99'S	100	5×10^{-4}	240	OIL-0057



CONTACT

 (+972)53-938-9696

 www.sda-tech.co.il

 office@sda-tech.com

 המסגר 9, מגדל העמק, ישראל

LVO 100/130/300



LVO 100 - שמן מינרלי איכותי למשאבות ואקום מדור נמוך, מתאים לשימוש כללי, מעניק אטימה טובה וביצועים יציבים.

LVO 130 - שמן סינתטי מבוסס הידרוקריקניג (Hydrocracked), מתאים לסביבות קשות, עמידות משופרת בחמצון, אידוי נמוך ואורך חיים יותר מ-LVO-100.

LVO 300 - שמן סינתטי מסוג POE למשאבות ואקום במערכות נקיות או תהליכים רגישים. מצוין לסביבות עם טמפרטורה גבוהה, ואקום גבוה במיוחד.

Model No.	צמיגות 40°C (cSt) C	לחץ אדים 20°C (mbar) C	נקודת הבזק (°C)	Part No.
LVO-100	100	1×10^{-3}	50-	OIL-0017
LVO-130	100	5×10^{-4}	45-	OIL-0062
LVO-300	220	1×10^{-6}	35-	OIL-0058



CONTACT

 (+972)53-938-9696

 www.sda-tech.co.il

 office@sda-tech.com

 המסגר 9, מגדל העמק, ישראל

(Mink) שמן גיר משאבות 220/150



150- שמן סינתטי, מספק הגנה מצוינת מפני שחיקה, חמצון וטמפרטורה גבוהה. מאפיין בצמיגות מאוזנת, אידוי נמוך ועמידות לאורך זמן.

220- שמן עבה יותר, נועד לתנאים קשים יותר, עומסים מכניים גבוהים או טמפ' סביבתיות מוגברות. מבטיח אטימה טובה יותר והפחתת שחיקה במערכות הדורשות צמיגות גבוהה יותר.

Model No.	צמיגות 40°C (cSt)	לחץ אדים 20°C (mbar)	נקודת הבזק (°C)	Part No.
OIL 150	150	5×10^{-4}	236	OIL-0028
OIL 220	220	5×10^{-4}	240	OIL-0029